

U  
M  
G  
E  
N  
I  
W  
A  
T  
E  
R

# Infrastructure Master Plan 2023 2023/2024 - 2053/2054

## Volume 9: uMfolozi System and uMkuze- uPhongolo-Lake Sibiya System



**Infrastructure Development Division, Umgeni Water**

310 Burger Street, Pietermaritzburg, 3201, Republic of South Africa  
P.O. Box 9, Pietermaritzburg, 3200, Republic of South Africa  
Tel: +27 (33) 341 1111 / Fax +27 (33) 341 1167 / Toll free: 0800 331 820  
Email: [info@umgeni.co.za](mailto:info@umgeni.co.za) / Web: [www.umgeni.co.za](http://www.umgeni.co.za)







For further information, please contact:

Planning Services  
Infrastructure Development Division  
Umgeni Water

P.O.Box 9, Pietermaritzburg, 3200  
KwaZulu-Natal, South Africa

Tel: 033 341-1522

Fax: 033 341-1218

Email: [info@umgeni.co.za](mailto:info@umgeni.co.za)

Web: [www.umgeni.co.za](http://www.umgeni.co.za)



# UMGENI WATER

## INFRASTRUCTURE MASTER PLAN 2023

2023/2024 – 2053/2054

JUNE 2023

Prepared by:

Digitally signed by MS  
DN: cn=MS, o=Umgeni Water,  
ou=Planning Services,  
email=mark.scott@umgeni.co.za, c=ZA  
Date: 2023.06.29 08:19:04 +02'00'

---

**Mark Scott** *PrTechEng*

Planning Engineer

Digitally signed by  
Mlungisi Shabalala  
Date: 2023.06.29 11:53:56  
+02'00'

---

**Mlungisi Shabalala** *PrSciNat*

Hydrologist

Approved by:

Digitally signed by Kevin Meier  
DN: cn=Kevin Meier, o=Umgeni  
Water, ou=Planning Services,  
email=kevin.meier@umgeni.co.za,  
c=ZA  
Date: 2023.06.28 15:54:52 +02'00'

---

**Kevin Meier** *PrEng*

Manager: Planning Services

Digitally signed by Kevin Meier  
DN: cn=Kevin Meier, o=Umgeni Water,  
ou=Planning Services,  
email=kevin.meier@umgeni.co.za, c=ZA  
Date: 2023.06.30 12:34:25 +02'00'

---

**Xolani Chamane** *PrEng*

Executive: Infrastructure Development





# PREFACE

This Infrastructure Master Plan 2023 describes:

- Umgeni Water’s infrastructure plans for the financial period 2023/2024 – 2053/2054, and
- Infrastructure master plans for other areas outside of Umgeni Water’s Operating Area but within KwaZulu-Natal.

It is a comprehensive technical report that provides information on current infrastructure and on future infrastructure development plans. This report replaces the last comprehensive Infrastructure Master Plan that was compiled in 2022.

The report is divided into **ten** volumes as per the organogram below.

**Volume 1** includes the following sections and a description of each is provided below:

- **Section 2** describes the most recent changes and trends within the primary environmental dictates that influence development plans within the province.
- **Section 3** relates only to the Umgeni Water Operational Areas and provides a review of historic water sales against past projections, as well as Umgeni Water’s most recent water demand projections, compiled at the end of 2021.
- **Section 4** describes Water Demand Management initiatives that are being undertaken by the utility and the status of Water Demand Management Issues in KwaZulu-Natal.
- **Section 5**, which also relates to Umgeni Water’s Operational Area, contains a high level review of the energy consumption used to produce the water volumes analysed in **Section 3**.
- **Section 6** provides an overview of the water resource regions and systems supplied within these regions.

The next eight volumes describe the current water resource situation and water supply infrastructure of the various systems in KwaZulu-Natal, including:

- **Volume 2 Section 7** Mgeni System.
- **Volume 3 Section 8** uMkhomazi System
- **Section 9** uMzimkhulu System
- **Section 10** Mzintlava System
- **Volume 4- Section 11** South Coast System
- **Volume 5 Section 12** North Coast System
- **Volume 6 Section 13** Upper uThukela System
- **Volume 7 Section 14** Buffalo System
- **Volume 8 Section 15** Middle uThukela System
- **Section 16** Mhlathuze System
- **Volume 9 Section 17** Umfolozi System
- **Section 18** uMkhuze / uPhongolo / Lake Sibiya System

**Volume 10, Section 19** describes the wastewater works currently operated by Umgeni Water (shown in pale brown in the adjacent figure) and provides plans for development of additional wastewater treatment facilities. The status of wastewater treatment in WSA’s that are not supplied by Umgeni Water are also described in this section.

# Infrastructure Master Plan 2023/2024

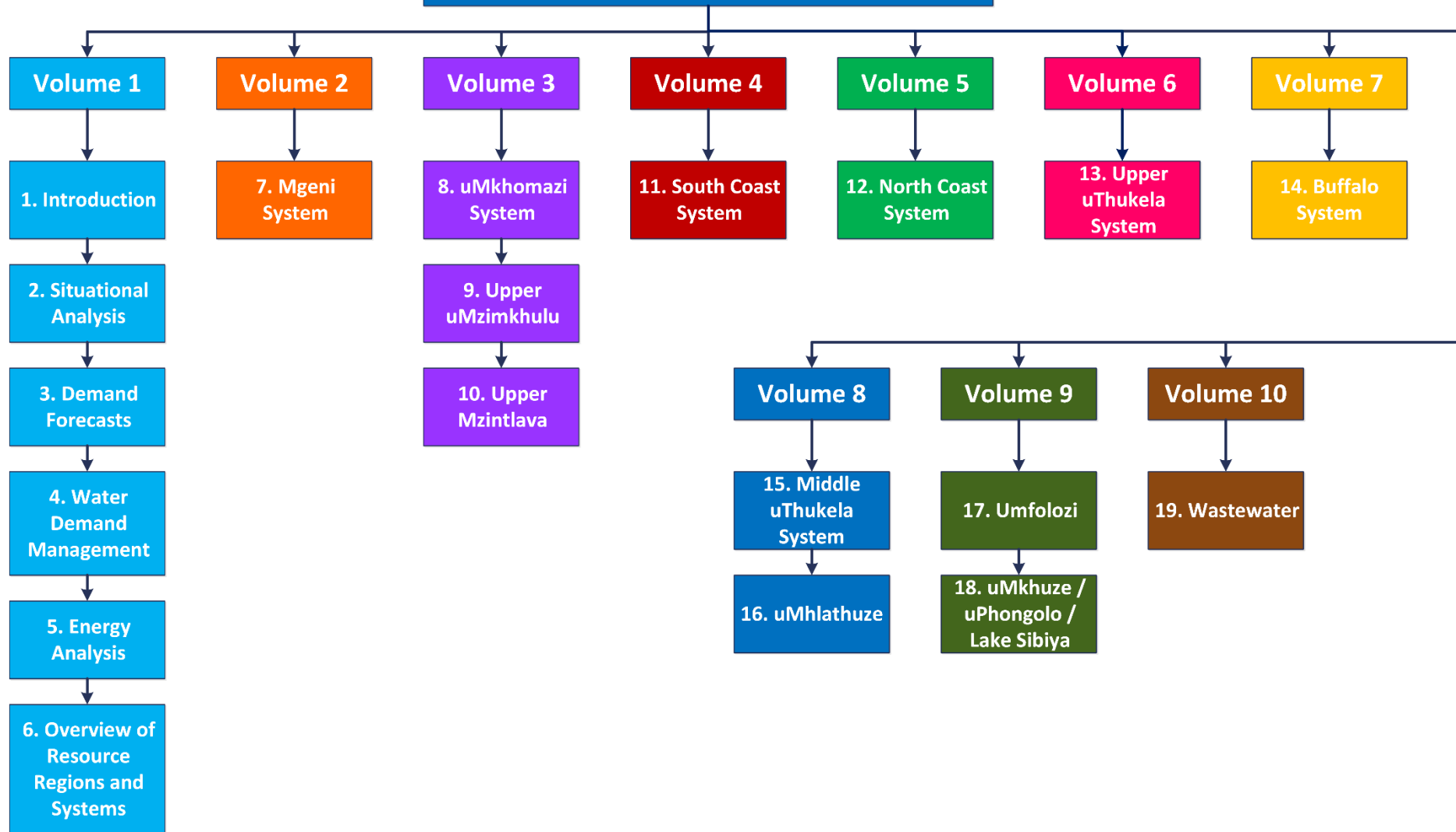

It is important to note that information presented in this report is in a summarised form and it is recommended that the reader refer to relevant planning reports if more detail is sought. Since the primary focus of this Infrastructure Master Plan is on bulk supply networks, the water resource infrastructure development plans are not discussed at length. The Department of Water and Sanitation (DWS), as the responsible authority, has undertaken the regional water resource development investigations. All of these investigations have been conducted in close collaboration with Umgeni Water and other major stakeholders in order to ensure that integrated planning occurs. Details on these projects can be obtained directly from DWS, Directorate: Options Analysis (East).

The Infrastructure Master Plan is a dynamic and evolving document. Outputs from current planning studies, and comments received on this document will therefore be taken into account in the preparation of the next update.



# TABLE OF CONTENTS

Preface .....	i
Table of Contents .....	iv
List of Figures .....	vi
List of Tables .....	viii
List of Acronyms.....	xi
List of Units .....	xiv
17. Mfolozi System .....	15
17.1 Synopsis of the Mfolozi System.....	15
17.2 Water Resources of the Mfolozi System .....	18
17.2.1 Description of the Mfolozi System Water Resource Region .....	18
17.2.2 Reserve .....	25
17.2.3 Existing Water Resource Infrastructure and Yields.....	26
17.2.4 Operating Rules.....	34
17.3 Supply Systems .....	40
17.3.1 Description of the Mfolozi System .....	40
17.3.2 Status Quo and Limitations of the Mfolozi System .....	74
17.4 Water Balance/Availability.....	76
17.5 Recommendations for the Mfolozi System .....	77
17.5.1 System Components .....	77
18. uMkhuze / uPhongolo / Lake Sibaya System.....	84
18.1 Synopsis .....	84
18.1.1 Water Resources.....	84
18.1.2 Reserve.....	103
18.1.3 Existing Water Resource Infrastructure and Yields .....	104
18.1.4 Operating Rules .....	110
18.2 Supply Systems .....	113
18.2.1 Description of the uMkhuze, Uphongolo and Lake Sibaya Water Supply Systems .....	113
18.2.2 uMkhuze Water Supply Supply .....	113
18.2.3 Hlobane/Coronation Water Supply System.....	118
18.2.4 Description of the uPhongolo System.....	123
18.2.5 Simdlangentsha Central Regional Bulk Water Supply Scheme (Belgrade BWSS) .....	135
18.2.6 Simdlangentsha East Regional Bulk Water Supply Scheme (Spekboom BWSS, uPhongolo BWSS).....	140
18.2.7 Mjindi Water Treatment Supply System (0.35 Ml/day) .....	152
18.2.8 Nondebuya Water Treatment Supply System.....	156
18.2.9 Othobothini Water Treatment Supply System.....	160
18.2.10 Jozini Water Treatment Supply System (Old & New).....	165
18.2.11 Shemula Water Treatment Supply System .....	172
18.3 Status Quo and Limitations .....	178
18.3.1 Hlobane/Coronation Supply System .....	178
18.3.2 uMkhuze Supply System .....	178
18.3.3 Simdlangentsha West RBWSS .....	179
18.3.4 Simdlangentsha Central RBWSS.....	180
18.3.5 Simdlangentsha East RBWSS.....	180
18.4 Water Balance/Availability.....	182
18.4.1 uMkhuze Water Supply System .....	182
18.4.2 uPhongolo Water Supply System .....	183
18.4.3 Lake Sibaya Water Supply Area.....	184

18.5	Recommendations .....	185
18.5.1	Simdlangentsha West Regional Bulk Water Supply Scheme (Frischgewaagd BWSS, Edumbe BWSS).....	185
18.5.2	Simdlangentsha Central Regional Bulk Water Supply Scheme (Belgrade BWSS) .....	185
18.5.3	Simdlangentsha East Regional Bulk Water Supply Scheme (Spekboom and Phongola WTP's Supply Systems) .....	186
18.5.4	Lake Sibaya and Mkhuze System.....	186
	References .....	188
	Acknowledgements.....	I

# LIST OF FIGURES

Figure 17.1	General layout of the Mfolozi System (MDB 2020, UW IMP 2021).....	17
Figure 17.2	General layout of the Mfolozi region (DEFF 2020, MDB 2020, Umgeni Water 2022, WR2012).....	21
Figure 17.3	Groundwater potential in the Mfolozi Region (MDB 2020, Umgeni Water 2022, after DWAF 1997 and WR2012).....	24
Figure 17.4	Klipfontein Dam ( <a href="https://vryheidherald.co.za">https://vryheidherald.co.za</a> ).....	28
Figure 17.5	Bloemveld Dam (Northern Natal News 2013: website).....	29
Figure 17.6	Grootgewacht Dam (DWA, 2015).....	30
Figure 17.7	Ulundi Balancing Weir (Google Earth Aerial View 2020: website).....	31
Figure 17.8	Vuna Dam (The Siyasiza Trust Facebook Photo upload: 2015).....	32
Figure 17.9	Vokwana Dam (Goole Photo: 2020).....	33
Figure 17.10	Mvunyana Dam (Goole Photo: 2020).....	34
Figure 17.11	Drought operating rule for Grootgewacht & Bloemveld sub-system for Vryheid – May decision month (DWS: 2013).....	36
Figure 17.12	Drought operating rule for Klipfontein Dam for Vryheid – May decision month (DWS: 2013).....	37
Figure 17.13	Drought operating rule for Mvunyane Dam–May decision month (DWS: 2013).....	38
Figure 17.14	Drought operating rule for Vokwana Dam–May decision month (DWA: 2013).....	40
Figure 17.15	Local Municipalities in Zululand District.....	41
Figure 17.16	Aerial view of the weir and Ulundi Water Treatment Plant.....	42
Figure 17.17	Aerial view of the Nkonjeni Dam and Nkonjeni Water Treatment Plant.....	44
Figure 17.18	Schematic layout of the Ulundi WTP Supply System.....	45
Figure 17.22	An Aerial view of the Mpungamhlope WTP (Google Earth 2020: website).....	49
Figure 17.23	Schematic of the Mpungamhlope Supply System.....	51
Figure 17.24	An Aerial view of the Usuthu WTP (Google Earth 2020: website).....	53
Figure 17.25	Schematic of the Usuthu Supply System.....	55
Figure 17.19	An Aerial view of the Vuna WTP and the Vuna Dam (Google Earth 2020: website).....	58
Figure 17.20	An Aerial view of the Embile WTP and the Embile Dam (Google Earth 2020: website).....	59
Figure 17.21	Schematic of the Vuna/Embile Supply System.....	61
Figure 17.26	An Aerial view of the Bloemveld WTP (Google Earth 2020: website).....	64
Figure 17.27	An Aerial view of the Klipfontein WTP (Google Earth 2020: website).....	65
Figure 17.28	Schematic of the Vryheid Supply System.....	67
Figure 17.29	An Aerial view of the Mondlo WTP (Google Earth 2020: website).....	70
Figure 17.30	Schematic of the eMondlo Supply System.....	72
Figure 17.31	General layout of the uPhongolo System (MDB 2020, UW IMP 2021).....	86
Figure 17.32	General layout of the uMkhuze System (MDB 2020, UW IMP 2021).....	87
Figure 17.33	General Layout of the uMkhuze Region (DEFF 2020, MDB 2020, Umgeni Water 2022, WR2012).....	91
Figure 17.34	General Layout of the uPhongolo Region (DEFF 2020, MDB 2020, Umgeni Water 2022, WR2012).....	92
Figure 17.35	General layout of Lake Sibayi Region (DEFF 2020, MDB 2020, Umgeni Water 2022, WR2012).....	93
Figure 17.36	Groundwater potential in the uMkhuze Region (MDB 2020, Umgeni Water 2021, after DWAF 1997 and WR2012).....	100
Figure 17.37	Groundwater potential in the Phongola Water Resource Region (MDB 2020, Umgeni Water 2022, after DWAF 1997 and WR2012).....	101



Figure 17.38	Groundwater potential in the Lake Sibaya Water Resource Region (MDB 2020, Umgeni Water 2022, after DWAF 1997 and WR2012). .....	102
Figure 17.39	Hluhluwe Dam (Lloyd Phillips 2017: <a href="https://www.farmersweekly.co.za/agri-business/empowerment/hluhluwe-farmers-assist-community-in-crisis/">https://www.farmersweekly.co.za/agri-business/empowerment/hluhluwe-farmers-assist-community-in-crisis/</a> ) .....	104
Figure 17.40	Bivane Dam - Source ( <a href="http://www.bestfishingspots.co.za/dam">http://www.bestfishingspots.co.za/dam</a> ) .....	106
Figure 17.41	Pongolapoort Dam – Source ( <a href="https://www.royaljozini.com/pongolapoort-dam-some-history/">https://www.royaljozini.com/pongolapoort-dam-some-history/</a> ).....	108
Figure 17.42	Lake Sibaya. ( <a href="https://infrastructurenews.co.za">https://infrastructurenews.co.za</a> ) .....	110
Figure 17.43	Hluhluwe Dam Drought Operating rules. DWS, 2016. ....	111
Figure 17.44	uMkhuze WTP ((Google Earth 2020: website). ....	114
Figure 17.45	Layout of uMkhuze WTP Supply System .....	116
Figure 17.46	Aerial View of the Hlobane WTP (Google Earth 2020: website). ....	119
Figure 17.47	Hlobane WTP (Google Earth 2020: website). ....	119
Figure 17.48	Aerial view of Coronation WTP (Google Earth 2020: website). ....	120
Figure 17.49	Schematic of the Hlobane/Coronation Supply System. ....	121
Figure 17.50	Local Municipalities in Zululand District (unknown source). ....	124
Figure 17.51	Aerial view of Edumbe Water Treatment Plant (Google Earth 2020: website). ....	125
Figure 17.52	Schematic of the Edumbe Supply System .....	127
Figure 17.53	Aerial view of Frischgewaagd Water Treatment Plant (Google Earth 2020: website).....	130
Figure 17.54	Schematic of Frischgewaagd WTP Supply System .....	132
Figure 17.55	Aerial view of Belgrade Water Treatment Plant (Google Earth 2020: website). ....	135
Figure 17.56	Schematic of Belgrade WTP Supply System .....	137
Figure 17.57	Aerial view of Spekboom Water Treatment Plant (Google Earth 2020: website). ..	140
Figure 17.58	Schematic of Spekboom WTP Supply System .....	142
Figure 17.59	Aerial view of Phongola Water Treatment Plant .....	145
Figure 17.60	Schematic of Phongola WTP Supply System .....	147
Figure 17.61	Aerial view of Mjindi Water Treatment Plant (Unknown source). ....	152
Figure 17.62	Schematic of Mjindi WTP Supply System .....	154
Figure 17.63	Aerial view of Nondebuya Water Treatment Plant & Nondabuya Reservoirs (unknown source). ....	156
Figure 17.64	Schematic of Nondebuya WTP Supply System .....	158
Figure 17.65	shows an aerial view of the Othobothini WTP (unknown source).....	160
Figure 17.66	Schematic of Othobothini WTP Supply System .....	162
Figure 17.67	Aerial view of Jozini Old Water Treatment Plant (Google Earth 2020: website). ....	165
Figure 17.68	Aerial view of Jozini New Water Treatment Plant (unknown source). ....	166
Figure 17.69	Aerial view of Jozini Reservoir (unknown source).....	166
Figure 17.70	Schematic of Jozini WTP Supply System .....	169
Figure 17.71	Schematic of Jozini WTP Supply System .....	170
Figure 17.72	Aerial view of the Shemula (Old) WTP (unknown source). ....	172
Figure 17.73	Aerial view of Shemula New Water Treatment Plant (Google Earth 2020: website).....	173
Figure 17.74	Schematic showing the Shemula Supply System .....	175
Figure 17.75	Construction of new 15 Mℓ /day WTP at Frischgewaagd along the Phongola River (Google Earth 2020: website). ....	179
Figure 17.76	Aerial view of Regional Water Treatment Plant (NEW) (unknown source). ....	181

# LIST OF TABLES

Table 17.1	Hydrological characteristics of the Mfolozi Region (WR2012: Usutu-Mhlatuze Quat Info WMA 6 7Jul2015 spreadsheet). .....	20
Table 17.2	Major dams in the White Mfolozi catchment (DWS 2014). .....	27
Table 17.3	Characteristics of Klipfontein Dam (DWS 2018: Hydrographic Surveys Dams Database, DWS 2019: List of Registered Dams Database, WR2012). .....	28
Table 17.4	Bloemveld Dam (DWS 2018: Hydrographic Surveys Dams Database, DWS 2019: List of Registered Dams Database, WR2012). .....	29
Table 17.5	Grootgewacht Dam (DWS 2019: List of Registered Dams Database, WR2012). .....	30
Table 17.6	Ulundi Weir (DWS 2019: List of Registered Dams Database, WR2012). .....	31
Table 17.7	Vuna Dam (DWS 2019: List of Registered Dams Database, WR2012). .....	32
Table 17.8	Vokwana Dam (DWS 2019: List of Registered Dams Database, WR2012). .....	33
Table 17.9	Characteristics of the Ulundi/Nkonjeni WTP's. ....	43
Table 17.10	Pump details: Ulundi/Nkonjeni Supply System .....	46
Table 17.11	Reservoir details: Ulundi/Nkonjeni RBWSS. ....	47
Table 17.12	Pipeline details: Ulundi/Nkonjeni RBWSS. ....	48
Table 17.17	Characteristics of the Mpungamhlope WTP .....	50
Table 17.18	Pump details: Mpungamhlope Supply System .....	52
Table 17.19	Reservoir details: Mpungamhlope BWSS. ....	52
Table 17.20	Pipeline details: Mpungamhlope BWSS. ....	52
Table 17.21	Characteristics of the Usuthu/Enyonkeni WTP's. ....	54
Table 17.22	Pump details: Usuthu Supply System .....	56
Table 17.23	Reservoir details: Usuthu BWSS. ....	56
Table 17.24	Pipeline details: Usuthu BWSS. ....	57
Table 17.13	Characteristics of the Vuna/Embile WTP's. ....	60
Table 17.14	Pump details: Vuna/Embile Supply System .....	62
Table 17.15	Reservoir details: Vuna/Embile BWSS. ....	62
Table 17.16	Pipeline details: Vuna/Embile BWSS. ....	63
Table 17.25	Characteristics of the Bloemveld/Klipfontin WTP's. ....	66
Table 17.26	Pump details: Vryheid Supply System .....	68
Table 17.27	Reservoir details: Vryheid BWSS. ....	68
Table 17.28	Pipeline details: Vryheid BWSS. ....	69
Table 17.29	Characteristics of the eMondlo WTP. ....	71
Table 17.30	Pump details: eMondlo Supply System .....	73
Table 17.31	Reservoir details: eMondlo BWSS. ....	73
Table 17.32	Pipeline details: eMondlo BWSS. ....	73
Table 17.33	Water balance - Water availability in the Mfolozi System for year 2000 (Zululand DM WSDP, 2004). .....	76
Table 17.34	Proposed Regional Water Schemes in the Zululand District Municipality .....	78
Table 17.35	Hydrological characteristics of the uMkhuze Region (WR2012: Thukela Quat Info WMA 7 7Jul2015 spreadsheet. ....	94
Table 17.36	Hydrological characteristics of uPhongolo Region (WR2012: Usutu-Mhlatuze Quat Info WMA 6 7Jul2015 spreadsheet). .....	94
Table 17.37	Lake Sibaya Hydrological Characteristics (WR2012: Thukela Quat Info WMA 7 7Jul2015 spreadsheet) .....	94
Table 17.38	Hluhluwe Dam (DWS 2018: Hydrographic Surveys Dams Database, DWS 2019: List of Registered Dams Database, WR2012). .....	105
Table 17.39	Hluhluwe Dam Yields (DWS, 2016). (Million m <sup>3</sup> /annum) .....	105
Table 17.40	Characteristics of Bivane Dam .....	107

Table 17.41	Characteristics of Pongolapoort Dam.	109
Table 17.42	Pongolapoort Dam Short term yields (DWS, 2018)	112
Table 17.43	Lake Sibayi water levels	112
Table 17.44	Characteristics of the uMkhuze WTP	115
Table 17.45	Pump Details	117
Table 17.46	Pipeline Details	117
Table 17.47	Reservoir Details	118
Table 17.48	Characteristics of the Hlobane/Coronation WTP's	121
Table 17.49	Pump Details	122
Table 17.50	Pipeline Details	122
Table 17.51	Reservoir Details	123
Table 17.52	Characteristics of the Edumbe WTP	126
Table 17.53	Pump details: Edumbe Supply System	128
Table 17.54	Reservoir details: Edumbe BWSS.	128
Table 17.55	Pipeline details: Edumbe BWSS.	128
Table 17.56	Characteristics of the Frischgewaagd WTP.	131
Table 17.57	Pump details: Frischgewaagd Supply System	133
Table 17.58	Reservoir details: Frischgewaagd BWSS.	133
Table 17.59	Pipeline details: Frischgewaagd BWSS.	134
Table 17.60	Characteristics of the Belgrade WTP.	136
Table 17.61	Pump details: Belgrade Supply System	138
Table 17.62	Reservoir details: Belgrade BWSS.	138
Table 17.63	Pipeline details: Belgrade BWSS.	139
Table 17.64	Characteristics of the Spekboom WTP.	141
Table 17.65	Pump details: Spekboom Supply System	143
Table 17.66	Reservoir details: Spekboom BWSS.	143
Table 17.67	Pipeline details: Spekboom BWSS.	144
Table 17.68	Characteristics of the Phongola WTP.	146
Table 17.69	Pump details: Phongola Supply System	148
Table 17.70	Reservoir details: Phongola BWSS.	150
Table 17.71	Pipeline details: Phongola BWSS.	151
Table 17.72	Characteristics of the Mjindi WTP.	153
Table 17.73	Mjindi Pump Details	155
Table 17.74	Mjindi Pipeline Details	155
Table 17.75	Mjindi Reservoir Details	155
Table 17.76	Characteristics of the Nondebuya WTP.	157
Table 17.77	Nondebuya Pipeline Details	159
Table 17.78	Nondebuya Reservoir Details	159
Table 17.79	Characteristics of the Othobothini WTP.	161
Table 17.80	Othobothini Pump Details	163
Table 17.81	Othobothini Pipeline Details	163
Table 17.82	Othobothini Reservoir Details	164
Table 17.83	Characteristics of the Jozini OLD WTP.	167
Table 17.84	Characteristics of the Jozini NEW WTP.	168
Table 17.85	Jozini Pump Details	171
Table 17.86	Jozini Pipeline Details	171
Table 17.87	Jozini Reservoir Details	171
Table 17.88	Characteristics of the Shemula NEW WTP.	174
Table 17.89	Shemula Pump Details	176
Table 17.90	Shemula Pipeline Details	176
Table 17.91	Shemula Reservoir Details	177



Table 17.92 Water Balance – Water availability in UMkhuze System for year 2000 (ZDM WSDP,2004).....	182
Table 17.93 uMkhuze Catchment Water Balance (Mhlathuze Water, 2016).....	183
Table 17.94 Water balance - Water availability in uPhongolo System (ZD WSDP, 2004).....	184

# LIST OF ACRONYMS

AADD	Annual Average Daily Demand
AC	Asbestos Cement
ADWF	Average Dry Weather Flow
API	Antecedent Precipitation Index
AVGF	Autonomous Valveless Gravity Filter
BID	Background Information Document
BPT	Break Pressure Tank
BWL	Bottom Water Level
BWSP	Bulk Water Services Provider
BWSS	Bulk Water Supply Scheme
CAPEX	Capital Expenditure
CMA	Catchment Management Agency
CoGTA	Department of Co-operative Governance and Traditional Affairs
CWSS	Community Water Supply and Sanitation project
DAEA	Department of Agriculture and Environmental Affairs
DEA	Department of Environmental Affairs
DEFF	Department of Environment, Forestry and Fisheries
DM	District Municipality
DRDLR	Department of Rural Development and Land Reform
DWA	Department of Water Affairs
DWS	Department of Water and Sanitation
DWAF	Department of Water Affairs and Forestry
EFR	Estuarine Flow Requirements
EIA	Environmental Impact Assessment
EKZN Wildlife	Ezemvelo KZN Wildlife
EMP	Environmental Management Plan
EWS	eThekweni Water Services
EXCO	Executive Committee
FC	Fibre Cement
FL	Floor level
FSL	Full Supply level
GCM	General Circulation Model
GDP	Gross Domestic Product
GDPR	Gross Domestic Product of Region
GVA	Gross Value Added
HDI	Human Development Index
IDP	Integrated Development Plan
IFR	In-stream Flow Requirements
IMP	Infrastructure Master Plan
IRP	Integrated Resource Plan

ISP	Internal Strategic Perspective
IWRM	Integrated Water Resources Management
KZN	KwaZulu-Natal
LM	Local Municipality
LUMS	Land Use Management System
MA	Moving Average
MAP	Mean Annual Precipitation
MAR	Mean Annual Runoff
MBR	Membrane Bioreactor
MMTS	Mooi-Mgeni Transfer Scheme
MMTS-1	Mooi-Mgeni Transfer Scheme Phase 1
MMTS-2	Mooi-Mgeni Transfer Scheme Phase 2
mPVC	Modified Polyvinyl Chloride
MTEF	Medium-Term Expenditure Framework
MTSF	Medium-Term Strategic Framework
MWP	Mkomazi Water Project
MWP-1	Mkomazi Water Project Phase 1
NCP-1	North Coast Pipeline I
NCP-2	North Coast Pipeline II
NCSS	North Coast Supply System
NGS	Natal Group Sandstone
NPV	Net Present Value
NRW	Non-Revenue Water
NSDP	National Spatial Development Perspective
NWSP	National Water Sector Plan
OPEX	Operating Expenditure
p.a.	Per annum
PES	Present Ecological Status
PEST	Political, Economical, Sociological and Technological
PGDS	Provincial Growth and Development Strategy
PPDC	Provincial Planning and Development Commission (KZN's)
PSEDS	Provincial Spatial Economic Development Strategy
PWSP	Provincial Water Sector Plan
RDP	Reconstruction and Development Programme
RO	Reverse Osmosis
ROD	Record of Decision
RQO	Resource Quality Objective
SCA	South Coast Augmentation
SCP	South Coast Pipeline
SCP-1	South Coast Pipeline Phase 1
SCP-2a	South Coast Pipeline Phase 2a
SCP-2b	South Coast Pipeline Phase 2b

SDF	Spatial Development Framework
SHR	St Helen’s Rock (near Port Shepstone)
STEEPLE	Social/demographic, Technological, Economic, Environmental (Natural), Political, Legal and Ethical
SWRO	Seawater Reverse Osmosis
TEC	Target Ecological Category
TWL	Top Water Level
uPVC	Unplasticised Polyvinyl Chloride
UW	Umgeni Water
WA	Western Aqueduct
WC	Water Conservation
WDM	Water Demand Management
WMA	Water Management Area
WRC	Water Research Commission
WSA	Water Services Authority
WSDP	Water Services Development Plan
WSNIS	Water Services National Information System
WSP	Water Services Provider
WTP	Water Treatment Plant
WWW	Wastewater Works

Spellings of toponyms have been obtained from the Department of Arts and Culture (DAC). DAC provides the official spelling of place names and the spellings, together with the relevant gazette numbers, can be accessed at <http://www.dac.gov.za/content/toponymic-guidelines-map-and-other-editors>.

When using any part of this report as a reference, please cite as follows:

Umgeni Water, 2023. *Umgeni Water Infrastructure Master Plan 2023/2024 – 2053/54, Vol 1 - 10*. Prepared by Planning Services, June 2023.

# LIST OF UNITS

<b>Length/Distance:</b>	mm	millimetre
	m	metre
	km	kilometre
<b>Area:</b>	m <sup>2</sup>	square metres
	ha	hectare
	km <sup>2</sup>	square kilometres
<b>Level/Altitude:</b>	mASL	metres above sea-level
<b>Time:</b>	s	second
	min	minute
	hr	hour
<b>Volume:</b>	m <sup>3</sup>	cubic metres
	Mℓ	megalitre
	million m <sup>3</sup>	million cubic metres
	mcm	million cubic metres
<b>Water Use/Consumption/Treatment/Yield:</b>	ℓ/c/day	litre per capita per day
	kℓ/day	kilolitre per day
	Mℓ/day	megalitre per day
	million m <sup>3</sup> /annum	million cubic metres per annum
	kg/hr	kilograms per hour
<b>Flow velocity/speed:</b>	m/s	metres per second
<b>Flow:</b>	m <sup>3</sup> /s	cubic metres per second
	ℓ/hr	litres per hour
	m <sup>3</sup> /hr	cubic metres per hour

# 17. MFOLOZI SYSTEM

---

## 17.1 Synopsis of the Mfolozi System

The Mfolozi Water Resource Region (Secondary Catchment W2) comprises of the White (Tertiary Catchment W21) and the Black Mfolozi Rivers (Tertiary Catchment W22), as well as the Mfolozi River (Tertiary Catchment W23) following the confluence of the Black and White Mfolozi Rivers on the south-eastern boundary of the Hluhluwe-Umfolozi Park. From the confluence, the Mfolozi River meanders in a south-easterly direction towards Mtubatuba, from where it flows north-east towards the St Lucia estuary and the Indian Ocean. Significant towns in the catchment include Vryheid, Mondlo, Ulundi, Babanango, Nongoma and Mtubatuba (**Figure 17.1**).

The Mfolozi River covers the Zululand and uMkhanyakude District Municipalities. These DMs play both the roles of Water Services Providers and Water Services Authorities in their respective areas of jurisdiction. This region remains one of the most under-serviced areas in the KwaZulu-Natal (KZN) province, with a significant portion of the population still lacking adequate water supply (UW, 2021). Major water resources infrastructure in the Mfolozi System include:

- The Klipfontein Dam (18.1 MCM), which is the largest water resource infrastructure in this river system, situated in the upper reaches of the White Mfolozi River. The dam was constructed to supply water to the town of Vryheid but can also be used to increase the water supply to Ulundi if necessary. Over the years, Vryheid's dependence on Klipfontein Dam has increased due to the rising water demands. However, there is an option of raising the dam to meet, not only Vryheid's growing water requirements, but other areas nearby.
- The Bloemveld Dam (2.27 MCM) and the Grootgewagen Dam (1.14 MCM). These dams were built for industrial use but also supplement domestic supply to Vryheid and surrounding areas.
- The Mvunyane Dam, in the Mvunyane River near Mondlo, which supplies water to Mondlo and surrounding areas. However, the Mvunyane Dam is significantly silted and interventions to implement efficient operating rules to avoid supply failure (UW, 2021).
- The Ulundi abstraction weir in the White Mfolozi River, south of Ulundi, which supplies water to Ulundi town and surrounding areas. The weir is gated and the gate is opened during high flows (summer) and closed during low flows (winter).
- The Vuna Dam on the Vuna River, east of Nongoma town, which supplies water to Nongoma and surrounding areas.
- Water transfer from the lower Mfolozi into the Mhlathuze system for industrial supply, mainly Richards Bay Minerals, just before the Mfolozi River flows into the Indian Ocean.

The water resources of the Black Mfolozi catchments are not secured and do not have an assured yield since the catchment is mostly undeveloped and underutilised. The annual estimates on water resources and the water requirements obscure the seasonal distribution. The run of river yield is completely different in the summer months when compared with the winter months for the same level of assurance of supply. Irrigation requirements can also have a strong seasonal variation, as does the environmental reserve. A reconciliation strategy study that includes the Usuthu Water Scheme, with estimated water



requirements of 2.5 million m<sup>3</sup>/annum, indicates that there is a deficit in the lower Black Mfolozi during the winter months owing to large-scale irrigation development near the mouth of the Mfolozi River and abstractions for transfer to the Mhlathuze catchments. This deficit can be overcome with the use of off channel storage to store the excess water available in summer for use in winter (Zululand DM ZD-WSDP, 2004).

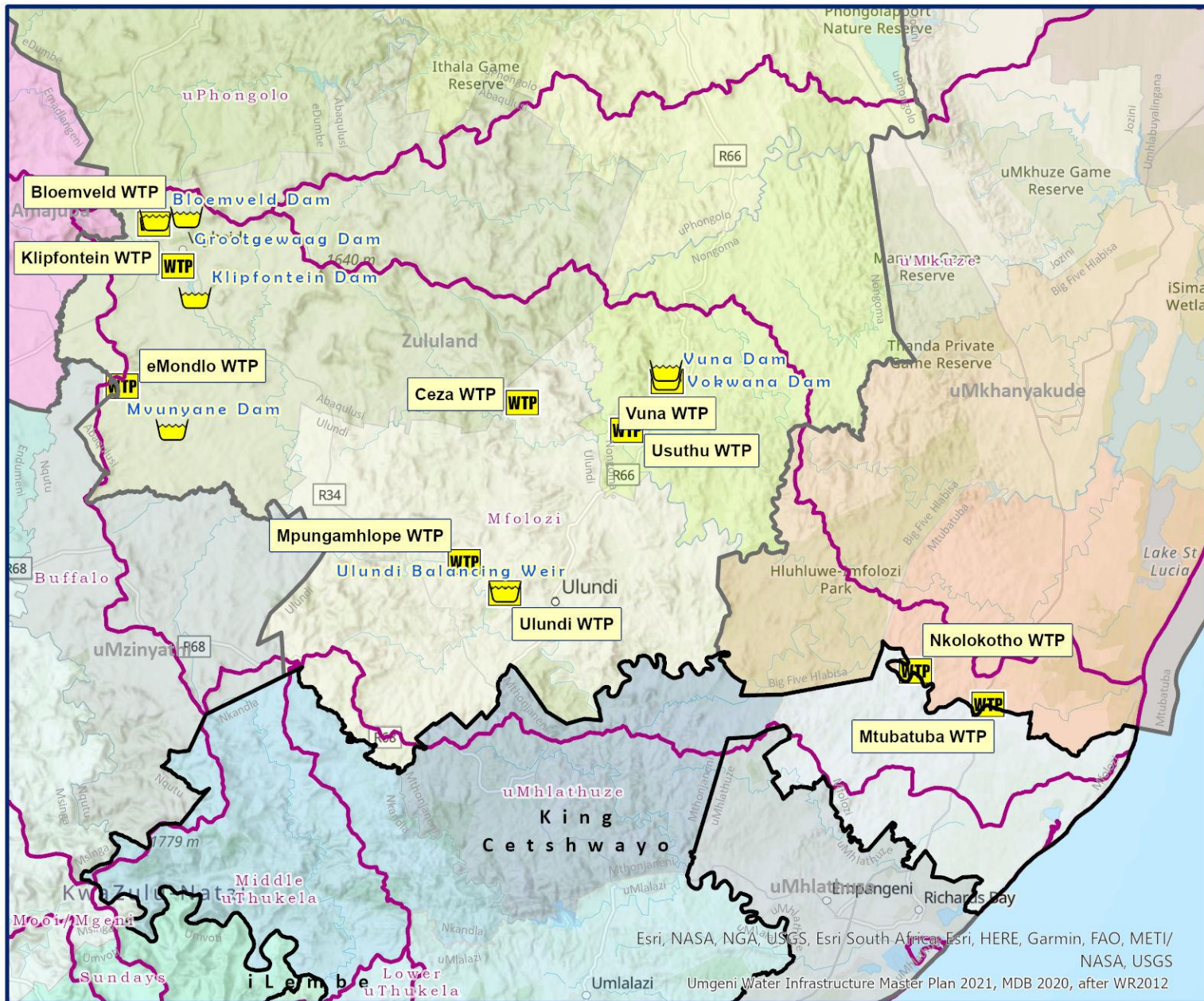

Figure 17.1 General layout of the Mfolozi System (MDB 2020, UW IMP 2021).

## 17.2 Water Resources of the Mfolozi System

### 17.2.1 Description of the Mfolozi System Water Resource Region

#### (a) Mfolozi region

##### (i) Overview

The Mfolozi River is the main river flowing along the south eastern boundary of the Hluhluwe-Mfolozi Game Reserve in the King Cetshwayo District Municipality (KCDM). The Mfolozi River flows south east into the Indian Ocean just north of Richards Bay. The Black and White Mfolozi Rivers are tributaries of the Mfolozi River and are part of the main rivers supplying water to Zululand District Municipality, with others being the uPhongolo and uMkhuze Rivers. The Mfolozi System is located in the secondary catchments W21, W22 and W23, covering a total area of approximately 10 000 km<sup>2</sup>.

The Mfolozi System is located in the secondary catchments W21, W22 and W23 with Klipfontein Dam serving as a domestic water supply dam for Vryheid and surrounding areas. The Klipfontein Dam is on the White Mfolozi River in Quaternary Catchment (QC) W21A in the upper reaches of the White Mfolozi River (**Figure 17.2**).

The White Mfolozi River (W21) catchment is positioned from the north-west to north-east of the town of Vryheid (QC W21A). To the east, the headwaters of the river are highly developed with several small land uses such as commercial forestry and commercial farmlands dominating this zone. Commercial forest plantations cover approximately 120 km<sup>2</sup>, while alien vegetation covers about 30 km<sup>2</sup> of upper reaches of the Mfolozi River catchment (Zululand DM ZD-WSDP, 2004). In terms of water resources infrastructure, QC W21A is significantly developed with major dams, i.e. the Grootgewaag and Bloemveld Dams, being situated in the upper reaches of the White Mfolozi River. The Klipfontein Dam, located about 5 km south of Vryheid (outlet of W21A), is the largest water resource infrastructure in the Upper Mfolozi catchment. This zone is also dominated by several small farm dams.

From the Klipfontein Dam, the White Mfolozi River flows in a south-easterly direction for about 12 km (as the crow flies) before its confluence with the Shoba River, which meanders in a south-westerly direction from its headwaters in QC W21B near Emandleni Primary School, passing through the Golden Valley Farm and crossing the R34 just before its confluence with the White Mfolozi River (27.936° S; 30.904° E). The White Mfolozi River continues to meander in a south-easterly direction before its confluence with the Lenjane River near Lenjane Drift (27.941° S; 30.960° E). Following the Lenjane River confluence, the White Mfolozi River then meanders in a south-west direction, passing through Brakfontein, before its confluence with the Sandspruit River (28.209° S; 30.949° E), which flows through QC W21C.

The White Mfolozi then meanders in a southerly direction, through QC W21F, to its confluence with the Mvunyane River near Kromellenboog. The Mvunyane River (W21D) sources is water from the western part of the Zululand District Municipality the Zululand District Municipality near Trig Beacon 36 (1531.3 mASL) where it forms the Umzinyathi-Zululand boundary. The town of eMondlo and surrounding residential areas such as Kwa Mabona, Nkandle and Machanca are located in the headwaters of the Mvunyane River. The largest water resource infrastructure in the Mvunyane River is the Mvunyane Dam, 7 km SE eMondlo town (as the crow flies). The major tributary of the Mvunyane River is the Jojosi River

(south-west) which sources its water near the Saint Pauls residential area (~1200 mASL). The Jojosi River flows south-easterly through its mountaneous catchment, forming the Zululand-Mzinyathi boundary. The Mangongoloza River flows in a north-easterly direction from the eNqutu town in the Mzinyathi DM areas such as Mathutshana, Mphondi and Madudula, before it joins the Jojosi River near Esigodini. From its confluence with the Mangongoloza River, the Jojosi River meanders to the north-east (with contributions from the Bhobopho, Khoqa and Mbondla streams from the south), forming the Zululand-Mzinyathi boundary, to its confluence with the Mvunyane River near Sofaya. From its confluence with the Jojosi River, the Mvunyane River continues to form the Zululand-Mzinyathi boundary, meandering in a southerly direction before its confluence with the Nondweni River (near Mhlungwane), which joins the Mvunyane River from the south-west. From its confluence with the Nondweni River, the Nondweni River, the Mvunyane River flows south-easterly into W21F, through Witklip and Kromellenboog farms, before meandering north, then eastwards where it joins the White Mfolozi, near Witpoort farm.

The White Mfolozi River then meanders in a south-westerly direction, through W21G, where it follows the Zululand-Mzinyathi boundary, with the Ntinini River joining it from the south-west. Following the Ntinini River confluence, the White Mfolozi then flows north-easterly before it is joined by the Nsubeni (from south) and Obombo Rivers (from northeast) near Obombo. The White Mfolozi River then meanders in a south-easterly direction, passing through the Leopard's Rock Nature Reserve into W21H, before flowing southwards to its confluence with the Nhlebela River (from the south-west) near Vlakhoek. The White Mfolozi River then meanders northwards towards its confluence with the Mvutshini River (from north-west) before flowing eastwards towards its confluence with the Tholeni River (from north), before flowing into the Mfolozi LM (King Cetshwayo DM).

The White Mfolozi River continues to flow in an easterly direction towards Mthinzima village, where it then meanders in a south-westerly direction, passing through the Matshitsholo Nature Reserve before its confluence with the Mpambeni River (from south-west) near KwaMbambo. From this confluence, the White Mfolozi River continues meandering in a south-easterly direction towards the Battle of Gqokli Hill, before flowing north-easterly through the Mfolozi Camp Festival, towards Ulundi. The Ulundi raw water abstraction weir is located south-west of the Ulundi town on the White Mfolozi River, at the outlet of QC U21J. This is a gate-controlled weir, where raw water is abstracted for supply into Ulundi town and surrounding areas. From the abstraction weir, the river then meanders in a south-easterly direction, south-west of Ulundi, towards the Ophathe Game Reserve. Thereafter, the White Mfolozi River meanders in a north-easterly direction towards its confluence with the Nhlungwane River at the outlet of W21K.

The White Mfolozi River then flows in a south-easterly direction, forming the KCDM-Mkhanyakude DM boundar, towards its confluence with the Mhlunywana River at the south-west corner of the Mkhanyakude DM. Thereafter, the White Mfolozi River meanders in a north-easterly direction through the Hluhluwe-Mfolozi Park towards the Mndindini Trails camp site. From Mndindini, the White Mfolozi flows southerly towards Makhamsa, from which it meanders north-easterly to its confluence with the Black Mfolozi River at the outlet of QC W21L.

The Black Mfolozi River sources its water from about 25 km east of Vryheid (W22A), near Trig Beacon 6 (1 628.3 mASL) in Hlobane. Major tributaries at the headwaters include the KwaMbizankulu and the Hlangebende Rivers which flow in in a north-easterly direction through QC W22B. From its confluence with the KwaMbizankulu and Hlangebende Rivers, the Black Mfolozi River meanders in a south-easterly direction towards its confluence with the Ithaka River (which flows from the south-west through W22D) near Chinso. The Black Mfolozi then meanders eastwards towards its confluence with the Sikwebezi River near the Mhambuma area. The Black Mfolozi River then meanders southerly, towards its confluence with



the Vuna River, which flows southwards through W22G. The Vuna River is an important source of water for the Nongoma area. Following its confluence with the Vuna River, the Black Mfolozi River meanders in a south-east direction through the Hluhluwe-Umfolozi Park in the Umkhanyakude DM, towards its confluence with the White Mfolozi River at the outlet of QC W22L. From the confluence, the Mfolozi River meanders in a south-easterly direction towards Mtubatuba, from which it flows north-east towards the St Lucia estuary in the Indian Ocean.

## (ii) Surface Water

Both the Black and White Mfolozi Rivers flow through predominately rural areas, characterised by natural grasslands and subsistence farming. Following the confluence of these two rivers, the Mfolozi River then flows into more developed urban areas, where commercial forest plantations and sugarcane are the main economic activities in the water source areas. The hydrological characteristics for this region are shown in **Table 17.1**.

**Table 17.1 Hydrological characteristics of the Mfolozi Region (WR2012: Usutu-Mhlatuze Quat Info WMA 6 7Jul2015 spreadsheet).**

Region	River (Catchment)	Area (km <sup>2</sup> )	Annual Average			
			Evaporation (mm)	Rainfall (mm)	Natural Runoff (million m <sup>3</sup> )	Natural Runoff (mm)
Mfolozi	W21 (White Mfolozi)	5274	1462	763	393.8	74.7
	W22 (Black Mfolozi)	3566	1202	808	277.1	77.7
	W23 (Mfolozi)	1168	1368	972	153.9	131.9

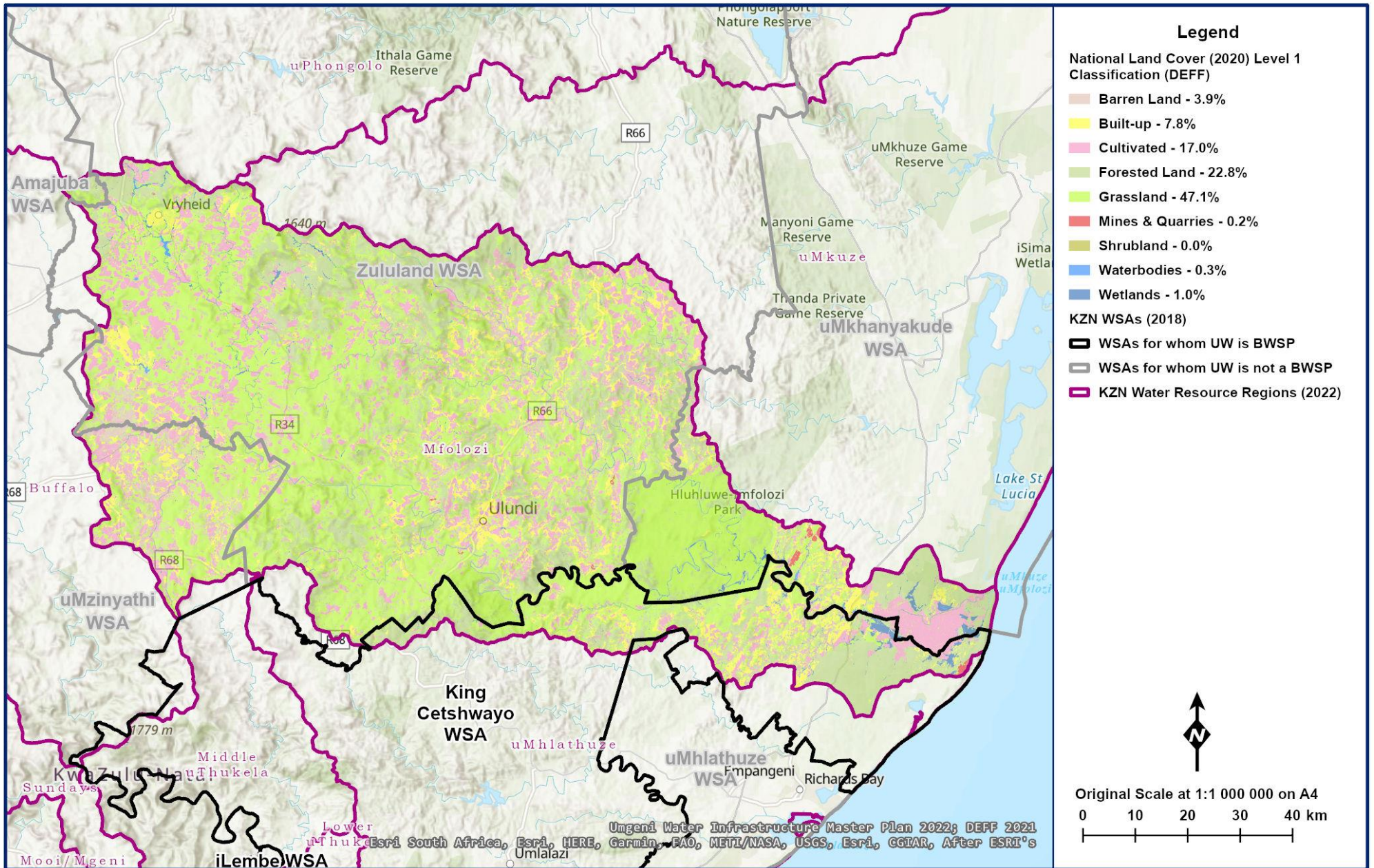

Figure 17.2 General layout of the Mfolozi region (DEFF 2020, MDB 2020, Umgeni Water 2022, WR2012).



### (iii) Groundwater

The Mfolozi region is located in three hydrogeological regions (**Figure 17.3**); the North Western Middleveld, North Eastern Middleveld and Southern Lebombo (DWAF, 2008).

#### • Hydrogeological Units

The Bumbeni Complex consists of a variable suite of sedimentary and volcanic rocks that include rhyolite, lavas, tuffs and basalt. With a few exceptions, virtually all the mountains, the flat-topped spurs and plateaux in the area are capped by dolerite sills.

The Vryheid Formation conformably overlies the Pietermaritzburg Formation. The Pietermaritzburg Formation is found resting conformably on the Dwyka Formation and unconformably on older basement rocks in the absence of the tillite.

The Natal Group overlies, unconformably, on the basement rocks. The Natal Group varies in thickness from a minimum of 15 m to about 500 m near Eshowe. To the north, its thickness decreases to about 150 m near Hlabisa.

The Tugela Group is present in four sub-horizontal thrust sheets made up of gneiss, amphibolitic hornblende schist formations and granitoid-gneiss formations.

#### • Geohydrology

The basalts occupy the flat and rolling hills immediately west of the Lebombo Mountains extending south as far as Empangeni. Virtually everywhere, the basalt is weathered to a depth of 10 to 15 m and forms very few outcrops.

Geophysical borehole logging has shown that the first water is generally struck at the base of the weathering zone.

Being more resistant to weathering than basalt rocks, the rhyolite rocks give rise to hills and ridges with very little soil cover or weathered overburden. Accordingly, all exploitable groundwater resources in these rock formations occur in saturated discontinuities such as fractures, joints and faults.

The intrusive dolerite sheets and dykes play an important role in influencing the movement and storage of groundwater. They are often jointed and fractured themselves, especially the sheet intrusions, but drilling results are more erratic when it penetrates the dolerite itself.

A great variety of sedimentary rocks comprising sandstone, shale, mudstone and Tillite underlie the study area. The largest volume of water utilised in the area is obtained from these rock types.

- **Groundwater Potential**

The lithology with the highest yielding boreholes is the Natal Group Sandstone with average yields of 5.0 ℓ/s. Second highest yielding is the basement granite at 1.2 ℓ/s. This is followed by the Pongola Supergroup with yields of 1.1 ℓ/s. The remaining lithologies in the area, namely Dwyka, Pietermaritzburg Formation, Vryheid Formation and Karoo Dolerite yield < 1 ℓ/s.

Although the yield of boreholes drilled directly into Dolerite are low, the impact of dolerite intrusions on other lithologies is significant. The dolerite intrusion disturbs the surrounding country rock increasing permeability and storativity of the contact zones due to fracturing and jointing and make them prime targets in the Karoo sediments for the drilling of boreholes.

Borehole yields are on average moderate having blow yields of > 0.5 – 3.0 ℓ/s but only 38 % have yields > 1 ℓ/s. Yields are poor in the east, around Nqutu and in areas where dolerite forms capping's on mountains. In the flatter, undulating areas south of Vryheid, where the dolerite is often deeply weathered, yields are moderate.

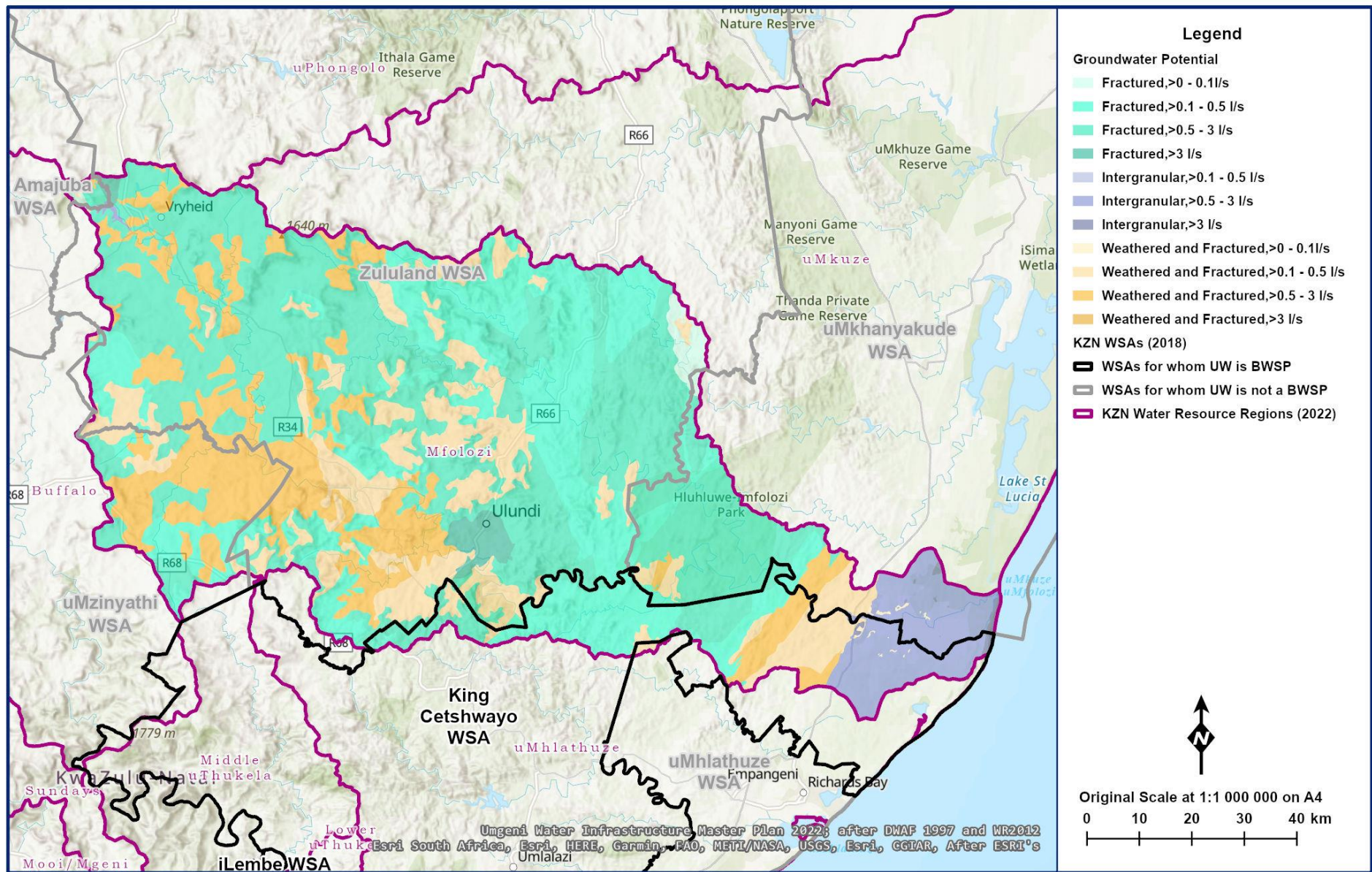

Figure 17.3 Groundwater potential in the Mfolozi Region (MDB 2020, Umgeni Water 2022, after DWA 1997 and WR2012).

#### (iv) Water Quality

- **Surface Water**

The water quality of uMfolozi headwaters is affected by coal fields in and around Vryheid and as result this places considerable pressure on the ecological and hydrological functioning of this water source area. Agriculture is the largest water user in this catchment, predominantly for sugarcane and forestry. The main threats to the water quality of the uMfolozi River are land degradation due to land use practices and coal mining. The uMfolozi River carries over a million tonnes of suspended sediment annually to the ocean and this has led to costly dredging operations in the estuary mouth which have proved ineffective.

- **Groundwater**

The chemical composition of natural groundwater is affected by the soluble products of rock weathering. The chemical characteristics of groundwater are reflected in many aspects of groundwater occurrence, recharge, movement and pollution.

The chloride content, as a percentage of the total dissolved solids, is generally very high in the area. However, it is effectively washed away in sections where the Mean Annual Rainfall (MAR) is high. In the central sections, surrounding Hlabisa, where the MAR is in excess of 1000 mm/annum, the chloride content in borehole water is lowest. Generally, the chloride content and electrical conductivity (EC) decreases as the distance from the Indian Ocean increases. This probably plays a role in the elevated salinity in some of the study area.

### 17.2.2 Reserve

#### (a) Mfolozi Region

The Department of Water and Sanitation is currently conducting a Water Resources Classification and Resource Quality Objectives Determination study for the Usutu to Mhlathuze Catchments. This study is expected to be completed in 2024. Preliminary results from the study show the following;

- All the Ecological Water Requirements (EWR) sites for the White Mfolozi River were assessed following a desktop approach. Results from this assessment shows that the PES of the White Mfolozi is generally B/C and the TEC is B/C. There are some areas where the PES could be improved, however, that is deemed difficult as non-flow mitigation measure are required (DWS, 2022). The winter and summer low flow Ecological Requirements (based on the desktop method) is 4 million m<sup>3</sup> for the four driest months and 30 million m<sup>3</sup> for the eight wettest months (DWS, 2015).
- A detailed approach will be followed for EWR sites in the Black Mfolozi River and will be reported once the detailes EWR analysis has been completed. From the DWS (2015) desktop analysis, the winter and summer low flow Ecological Reserve, is 4 million m<sup>3</sup> for the four driest months and 26 million m<sup>3</sup> for the eight wettest months.



## 17.2.3 Existing Water Resource Infrastructure and Yields

### (a) Mfolozi Region

The major dams of the White Mfolozi River are shown in **Table 17.2**. These include the Klipfontein Dam (**Figure 17.4**,

**Table 17.3**), the Bloemveld Dam (**Figure 17.5, Table 17.4**), the Grootgewacht Dam (**Figure 17.6, Table 17.5**), the Ulundi Weir (**Figure 17.7, Table 17.6**), the Vuna Dam (**Figure 17.8, Table 17.7**), the Vokwana Dam (**Figure 17.9, Table 17.8**) and the Mvunyana Dam (**Figure 17.10**).

The largest water resources development in the catchment is the Klipfontein Dam (capacity 18.09 million m<sup>3</sup>/annum). This dam is positioned in the upper reaches of the White Mfolozi River. The dam was built to supply water to Vryheid town but can also be used to increase the water supply to Ulundi. The challenge in this region is not that there is not enough water but a lack of storage which results in low firm yields and water shortages occur during drought events (Umgeni Water 2019: 34).

Based on the 2019 Zululand DM UAP Phase III report, a reconnaissance level water resource catchment study for the White Mfolozi River was undertaken in 2009/2010. The yield analysis indicated that there is insufficient water to meet the requirements (year 2009/2010) of eMondlo LM at 98 % assurance and by 2030 there will be significant shortfalls in the water availability to meet the requirements of all the main towns, especially if Ecological Water Requirements are released from the main dams (Umgeni Water 2019: 34).

The 2018/2019 WSDP review indicates that the Zululand DM undertook a Water Resource Modelling exercise for the upper White Mfolozi River System during 2011/2012. The results indicated that the yield from the Mvunyane Dam is insufficient to meet the requirements at the desired levels of assurance and should be augmented to avoid the risk of restrictions occurring. The model also indicated that if a high growth scenario is anticipated, the yield from Klipfontein Dam will be sufficient to meet the water requirements of Vryheid, Ulundi and eMondlo only until 2021 (Umgeni water 2019:34).

Based on the 2019 uMkhanyakude DM UAP Phase III report, the domestic allocations on the Mfolozi are for the Mpukonyoni and Mtubatuba schemes, and each scheme has an allocation of 3.65 million m<sup>3</sup>/annum (10 Mℓ/day). The available yield at the Mpukonyoni abstraction site is not known, but regular operational issues (as a result of low river levels) indicate that there is limited availability on a consistent basis. The Mpukonyoni Scheme shares the water resources of the Mfolozi River with the Mtubatuba Supply area.

Of greatest significance to uMkhanyakude DM is the yield of the Mfolozi at the point of abstraction for Mtubatuba. For this, the low flow runoff is most significant in terms of reliability of supply throughout the year. The low flow runoff of the Mfolozi River with a 1:50 year recurrence interval being available at the Mtubatuba abstraction works will be approximately 5.26 million m<sup>3</sup> and 8.09 million m<sup>3</sup> for the 1-month and 3 month durations respectively. This translates to approximately 7.39 million m<sup>3</sup>/annum (20.2 Mℓ/day). However, because of the sandy nature of the Mfolozi River, only 50% (3.7 million m<sup>3</sup>/annum) (10.1 Mℓ/day) of this low flow is available over the whole year.

**Table 17.2 Major dams in the White Mfolozi catchment (DWS 2014).**

Dam	Year Built	FSC 10 <sup>6</sup> m <sup>3</sup>	Quat	MAR 10 <sup>6</sup> m <sup>3</sup> /a	Histoical Firm Yield 10 <sup>6</sup> m <sup>3</sup> /a	1:50 Yield 10 <sup>6</sup> m <sup>3</sup> /a
Klipfontein	1983	18.1	W21A	49.1	16.6	13.5
Bloemveld	1969	2.7	W21A	9.8	1.1	1.82 <sup>a</sup>
Grootgewacht	1948	1.1	W21A	4.9	0.6	
Mvunyana	1970	2.9	W21D	13.1	4.0	2.7 <sup>b</sup>
Ulundi Weir	1995	0.6	W21H	289.7	34	2.8 <sup>b</sup>

<sup>a</sup> Bloemveld with support from Grootgewacht

<sup>b</sup> May decision date short-term yield

Sedimentation, as a result of poor land use practices and natural processes, impacts the water resources of the catchment. There is a high siltation rate at Ulundi weir and this requires occasional flushing although this does not compensate for the loss in storage. Any proposed storage or abstraction on the White Mfolozi River should include a study to minimise the impact on sediment.

The 2020 Zululand DM UAP Phase III report recommends the raising of Klipfontein Dam, as a means of addressing the water resource shortages in the area. This was also proposed in the First Order Reconciliation Strategies. The construction of a proposed off-channel storage dam on the KwaNkweme River with a run-of-river scheme on the upper Black Mfolozi River could supply a target abstraction of 18.6 Mℓ/day (the projected water requirement for the proposed scheme in 2025). The annual risk of failure of this development would be approximately 64%. This risk is above the accepted levels (assurance of supply) of the system (UW, 2020).





Figure 17.4 Klipfontein Dam (<https://vryheidherald.co.za>)

Table 17.3 Characteristics of Klipfontein Dam (DWS 2018: Hydrographic Surveys Dams Database, DWS 2019: List of Registered Dams Database, WR2012).

Catchment Details	
Incremental Catchment Area:	340 km <sup>2</sup> <sup>a</sup>
Total Catchment Area:	340 km <sup>2</sup> <sup>a</sup>
Mean Annual Precipitation:	879 mm <sup>b</sup>
Mean Annual Runoff:	35.11million m <sup>3</sup> <sup>b</sup>
Annual Evaporation:	1045 mm <sup>b</sup>
Dam Characteristics	
Gauge Plate Zero:	1071.1 mASL <sup>c</sup>
Full Supply Level:	1090 mASL <sup>c</sup>
Net Full Supply Capacity:	17.811 million m <sup>3</sup> <sup>c</sup>
Spillway Height:	28 m <sup>c</sup>
Dead Storage:	1.181 million m <sup>3</sup> <sup>c</sup>
Total Capacity:	17.811 million m <sup>3</sup> <sup>c</sup>
Original Measured Dam Capacity:	18.992 million m <sup>3</sup> (1983) <sup>d</sup>
Second Measured Dam Capacity:	18.970 million m <sup>3</sup> (1984) <sup>d</sup>
Third Measured Dam Capacity:	18.088 million m <sup>3</sup> (2000) <sup>d</sup>
Fourth Measured Dam Capacity:	17.811 million m <sup>3</sup> (2016) <sup>d</sup>
Surface Area of Dam at Full Supply Level:	2.959 km <sup>2</sup> <sup>c</sup>
Dam Type:	Earth-fill <sup>c</sup>
Material Content of Dam Wall:	Earth Fill <sup>c</sup>
Crest Length:	Crest length: 970 m <sup>e</sup> Spillway Section: 12 m <sup>e</sup> Non-Spillway Section: 958 m <sup>e</sup>
Type of Spillway:	Earth Fill <sup>c</sup>
Capacity of Spillway:	1250 <sup>f</sup>
Date of Completion:	1983 <sup>c</sup>
Date of Last Area Capacity Survey:	2016 <sup>d</sup>
Date of Next Area Capacity Survey:	2031 <sup>d</sup>

<sup>a</sup> Catchment delineated using 20m DEM and Spatial Analyst.

<sup>b</sup> WR2012.

<sup>c</sup> DWS List of Registered Dams Database (April 2019).

<sup>d</sup> DWS Hydrographic Surveys Dams Database (2018).

<sup>e</sup> Measured on Google Earth.

<sup>f</sup> SANCOLD



Figure 17.5 Bloemveld Dam (Northern Natal News 2013: website)

Table 17.4 Bloemveld Dam (DWS 2018: Hydrographic Surveys Dams Database, DWS 2019: List of Registered Dams Database, WR2012)

<b>Catchment Details</b>	
Incremental Catchment Area:	59 km <sup>2 a</sup>
Total Catchment Area:	59 km <sup>2 a</sup>
Mean Annual Precipitation:	879 mm <sup> b</sup>
Mean Annual Runoff:	10.37 million m <sup>3 b</sup>
Annual Evaporation:	1450 mm <sup> b</sup>
<b>Dam Characteristics</b>	
Gauge Plate Zero:	1232.5 mASL <sup> g</sup>
Full Supply Level:	1250.5 mASL <sup> g</sup>
Net Full Supply Capacity:	2.27 million m <sup>3 c</sup>
Spillway Height:	18 m <sup> c</sup>
Dead Storage:	N/A
Total Capacity:	2.27 million m <sup>3 e</sup>
Original Measured Dam Capacity:	2.27 million m <sup>3 (1971) d</sup>
Surface Area of Dam at Full Supply Level:	0.64 km <sup>2 c</sup>
Dam Type:	Earth-fill <sup> c</sup>
Material Content of Dam Wall:	Earth-fill <sup> c</sup>
Crest Length:	Crest length: 424 m <sup> d</sup> Spillway Section: 8 m <sup> d</sup> Non-Spillway Section: 416 m <sup> d</sup>
Type of Spillway:	Side Channel And Uncontrolled Ogee <sup> c</sup>
Capacity of Spillway:	275 <sup> f</sup>
Date of Completion:	1969 <sup> c</sup>
Date of Last Area Capacity Survey:	1971 <sup> d</sup>
Date of Next Area Capacity Survey:	2006 (Overdue) <sup> d</sup>

<sup>a</sup> Catchment delineated using 20m DEM and Spatial Analyst.

<sup>b</sup> WR2012.

<sup>c</sup> DWS List of Registered Dams Database (April 2019).

<sup>d</sup> DWS Hydrographic Surveys Dams Database (2018).

<sup>f</sup> SANCOLD

<sup>g</sup> 0.5 m contour from DEM





Figure 17.6 Grootgewacht Dam (DWA, 2015)

Table 17.5 Grootgewacht Dam (DWS 2019: List of Registered Dams Database, WR2012)

<b>Catchment Details</b>	
Incremental Catchment Area:	16.3 km <sup>2</sup> <sup>a</sup>
Total Catchment Area:	16.3 km <sup>2</sup> <sup>a</sup>
Mean Annual Precipitation:	879 mm <sup>b</sup>
Mean Annual Runoff:	2.87 million m <sup>3</sup> <sup>b</sup>
Annual Evaporation:	1450 mm <sup>b</sup>
<b>Dam Characteristics</b>	
Gauge Plate Zero:	1300.3 mASL
Full Supply Level:	1312.5 mASL
Net Full Supply Capacity:	1.136 million m <sup>3</sup> <sup>c</sup>
Spillway Height:	12.19 m <sup>c</sup>
Dead Storage:	N/A
Total Capacity:	1.136 million m <sup>3</sup> <sup>c</sup>
Original Measured Dam Capacity:	1.136 million m <sup>3</sup> <sup>c</sup>
Surface Area of Dam at Full Supply Level:	0.30 km <sup>2</sup> <sup>c</sup>
Dam Type:	Gravity <sup>c</sup>
Material Content of Dam Wall:	Unknown at this stage
Crest Length:	Crest length: 132 m <sup>d</sup> Spillway Section: 30 m <sup>d</sup> Non-Spillway Section: 102 m <sup>d</sup>
Type of Spillway:	Uncontrolled Ogee And Side Channel <sup>c</sup>
Capacity of Spillway:	N/A
Date of Completion:	1948 <sup>c</sup>
Date of Last Area Capacity Survey:	2008 <sup>c</sup>
Date of Next Area Capacity Survey:	N/A

<sup>a</sup> Catchment delineated using 20m DEM and Spatial Analyst.

<sup>b</sup> WR2012.

<sup>c</sup> DWS List of Registered Dams Database (April 2019).

<sup>d</sup> Measured on Google Earth.

<sup>e</sup> 0.5 m from DEM





Figure 17.7 Ulundi Balancing Weir (Google Earth 2020)

Table 17.6 Ulundi Weir (DWS 2019: List of Registered Dams Database, WR2012)

<b>Catchment Details</b>	
Incremental Catchment Area:	407 km <sup>2</sup> <sup>a</sup>
Total Catchment Area:	407 km <sup>2</sup> <sup>a</sup>
Mean Annual Precipitation:	780 mm <sup>b</sup>
Mean Annual Runoff:	32.64 million m <sup>3</sup> <sup>b</sup>
Annual Evaporation:	1500 mm <sup>b</sup>
<b>Weir Characteristics</b>	
Net Full Supply Capacity:	0.24 million m <sup>3</sup> <sup>c</sup>
Spillway Height:	11 m <sup>c</sup>
Total Capacity:	0.24 million m <sup>3</sup> <sup>c</sup>
Original Measured Dam Capacity:	0.24 million m <sup>3</sup> <sup>c</sup>
Surface Area of Dam at Full Supply Level:	0.18 km <sup>2</sup> <sup>c</sup>
Dam Type:	Gravity <sup>c</sup>
Material Content of Dam Wall:	Gravity <sup>c</sup>
Crest Length:	Crest length: 147 m <sup>c</sup> Spillway Section: 37 m <sup>d</sup> Non-Spillway Section: 110 m <sup>d</sup>
Type of Spillway:	Ogee Spillway <sup>c</sup>
Capacity of Spillway:	N/A
Date of Completion:	1995 <sup>c</sup>
Date of Last Area Capacity Survey:	2005
Date of Next Area Capacity Survey:	N/A

<sup>a</sup> Catchment delineated using 20m DEM and Spatial Analyst.

<sup>b</sup> WR2012.

<sup>c</sup> DWS List of Registered Dams Database (April 2019).

<sup>d</sup> Measured on Google Earth.





Figure 17.8 Vuna Dam (The Siyasiza Trust Facebook Photo upload: 2015)

Table 17.7 Vuna Dam (DWS 2019: List of Registered Dams Database, WR2012)

<b>Catchment Details</b>	
Incremental Catchment Area:	116.8 km <sup>2</sup> <sup>d</sup>
Total Catchment Area:	116.8 km <sup>2</sup> <sup>d</sup>
Mean Annual Precipitation:	774 mm <sup>a</sup>
Mean Annual Runoff:	17.9million m <sup>3</sup> <sup>a</sup>
Annual Evaporation:	1500 mm <sup>a</sup>
<b>Dam Characteristics</b>	
Gauge Plate Zero:	365 mASL <sup>c</sup>
Full Supply Level:	376 mASL <sup>c</sup>
Spillway Height:	11 m <sup>b</sup>
Net Full Supply Capacity:	0.9 million m <sup>3</sup> <sup>b</sup>
Dead Storage:	N/A
Total Capacity:	0.9 million m <sup>3</sup> <sup>b</sup>
Surface Area of Dam at Full Supply Level:	0.36 km <sup>2</sup>
Original Measured Dam Capacity	0.9 million m <sup>3</sup> <sup>b</sup>
Dam Type:	Earth-fill <sup>b</sup>
Crest Length:	Crest Length: 378 m <sup>c</sup> Spillway Section: 122 m <sup>c</sup> Non-Spillway Section: 256 m <sup>c</sup>
Type of Spillway:	Uncontrolled
Capacity of Spillway:	N/A
Date of Completion:	1986 <sup>b</sup>
Date of Area Capacity Survey:	1996 <sup>b</sup>
Date of next Area Capacity Survey:	N/A

<sup>a</sup> WR2012 Database of Quaternary Catchment Information.

<sup>b</sup> DWS List of Registered Dams Database (April 2019).

<sup>c</sup> Measured on Google Earth.

<sup>d</sup> DWA, 2013.



Figure 17.9 Vokwana Dam (Google Earth 2020)

Table 17.8 Vokwana Dam (DWS 2019: List of Registered Dams Database, WR2012).

<b>Catchment Details</b>	
Incremental Catchment Area:	16.1 km <sup>2</sup> <sup>d</sup>
Total Catchment Area:	16.1 km <sup>2</sup> <sup>d</sup>
Mean Annual Precipitation:	774 mm <sup>a</sup>
Mean Annual Runoff:	2.4 million m <sup>3</sup> <sup>a</sup>
Annual Evaporation:	1500 mm <sup>a</sup>
<b>Dam Characteristics</b>	
Gauge Plate Zero:	373 mASL <sup>c</sup>
Full Supply Level:	398 mASL <sup>c</sup>
Spillway Height:	25 m <sup>b</sup>
Net Full Supply Capacity:	1.45 million m <sup>3</sup> <sup>b</sup>
Dead Storage:	0.26million m <sup>3</sup> <sup>b</sup>
Total Capacity:	1.71 million m <sup>3</sup> <sup>b</sup>
Surface Area of Dam at Full Supply Level:	0.23 km <sup>2</sup> <sup>b</sup>
Original Measured Dam Capacity	1.71 million m <sup>3</sup> <sup>b</sup>
Dam Type:	Earth-fill <sup>b</sup>
Crest Length:	Crest Length: 350 m <sup>b</sup>
Type of Spillway:	Uncontrolled Ogee <sup>b</sup>
Capacity of Spillway:	N/A
Date of Completion:	2000 <sup>b</sup>
Date of Area Capacity Survey:	2000 <sup>b</sup>
Date of next Area Capacity Survey:	N/A

<sup>a</sup> WR2012 Database of Quaternary Catchment Information.

<sup>b</sup> DWS List of Registered Dams Database (April 2019).

<sup>c</sup> Measured on Google Earth.

<sup>d</sup> DWA, 2013.





**Figure 17.10 Mvunyana Dam (Google Earth 2020)**

## 17.2.4 Operating Rules

### (a) Mfolozi Region

Supply to Vryheid comes from mainly Bloemveld and Grootgewagdt (or Grootgewacht) Dams and to lesser extent from Klipfontein Dam. Ulundi supply comes from an abstraction weir on the White Mfolozi River, this weir has gates that are closed in winter to capture low flows. The gates are opened in summer to avoid weir siltation. The yield of the river is supplemented with releases from Klipfontein Dam during low flows.

In May 2010, the then Department of Water Affairs (DWA) undertook a study titled “***The development of Water supply and Drought Operating Rules for Stand-Alone Dams and Schemes***”. As part of the study, water supply and drought operating rules were developed for 10 schemes (consisting of 21 dams) within DWA’s Eastern Cluster (DWA 2010: 1).

Five of the identified supply schemes form part of the White Mfolozi River Catchment. These included:

- The Vryheid Regional Water Supply Scheme (WSS);
- The eMondlo Water Supply Scheme;
- The Ulundi Water Supply Scheme;
- The Mpungamhlope Water Supply Scheme; and
- The Nondweni Water Supply Scheme.

Operating rules results for the above-mentioned Water Supply Schemes are described below.

## Upper Mfolozi Water Supply Operating Rule

The analyses were based on the 2012 development level and the order/priority of water supply from the different resources to the various WSS was confirmed from various stakeholders DWA (2010). Key findings from the DWA (2010) Water Supply and Drought operating rules report included:

- The Vryheid WSS uses water from Grootgewacht and Bloemveld dams first up to the limit of the infrastructure and the balance of the water requirements are then abstracted from the Klipfontein Dam;
- The Bloemveld Dam should be supported by the Grootgewacht Dam;
- The eMondlo WSS abstracts water from the Mvunyana Dam. A transfer from Klipfontein Dam was planned to be constructed by 2019/2020 to improve the reliability of water supply to eMondlo. When the transfer is complete, eMondlo shall abstract water from Mvunyana Dam first and then from Klipfontein Dam (to be tested and confirmed). This may require the raising of the Klipfontein Dam Wall.
- The Mpungamhlope WSS abstracts water from the White Mfolozi River just upstream of the Ulundi balancing weir. When there is insufficient flow in the river this abstraction is supported by releases from the Klipfontein Dam.
- The Ulundi WSS is supplied from the Ulundi balancing weir which is supported by releases from the Klipfontein Dam. Water should only be released from Klipfontein Dam when the incremental flows are not sufficient to support the abstraction to the Ulundi WTP.

## Upper White Mfolozi Drought Operating Rule

A drought operating rule was also developed using the above-mentioned supply sequence from the available resources. This estimated the volume of water that can be allocated to users based on storage levels in the dams. This allocation is based on the volume of water that can reliably be drawn from the system without increasing the risk of failure.

A DWA (2013) report confirmed the analyses that were carried out and showed the following:

- **Grootgewacht & Bloemveld Dam sub-system:** the volume of water that can be supplied from the Grootgewacht and Bloemveld Dams was reduced as the levels in these two dams decreased. In addition, the maximum volume of water that can be reliably supplied from this system, without running the risk of these dams failing, is in the order of 2 million m<sup>3</sup>/annum. Thereafter, the balance of the Vryheid WSS's water requirement should be supplied from the Klipfontein Dam (**Figure 17.11**).

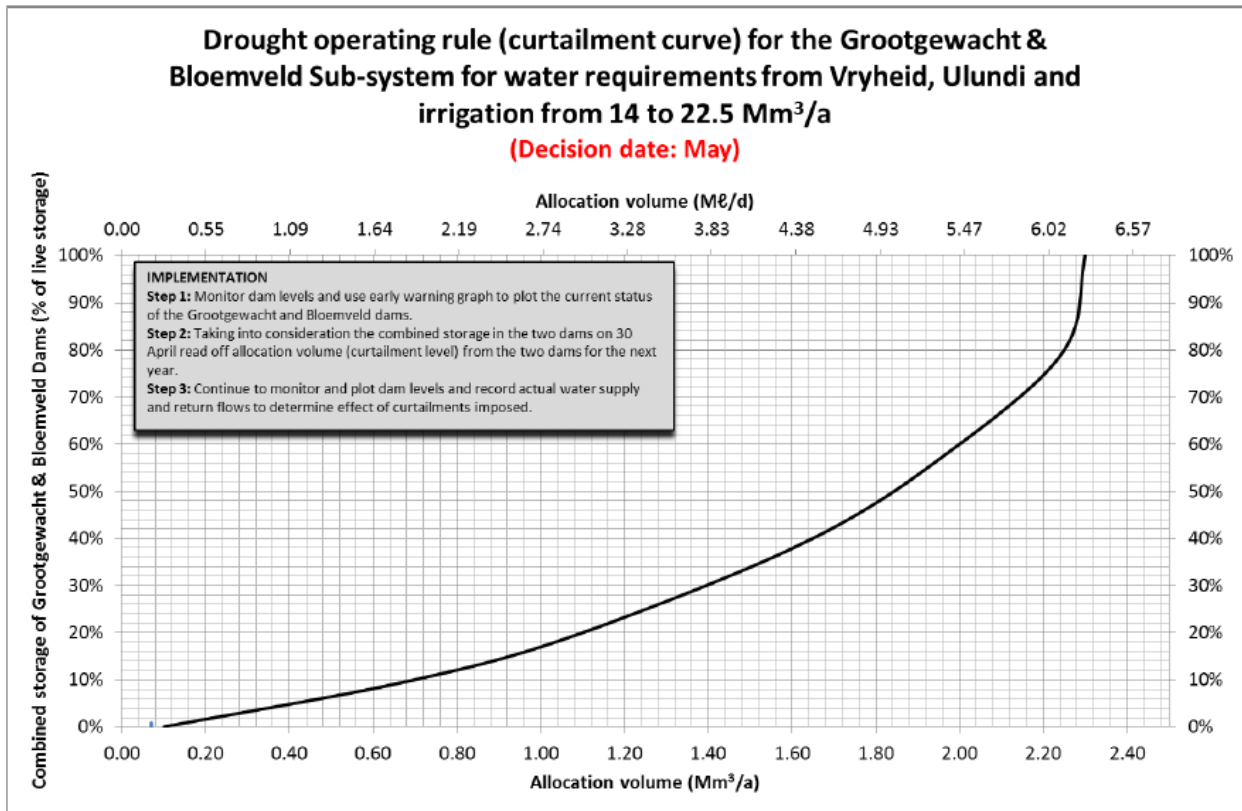

**Figure 17.11 Drought operating rule for Grootgewacht & Bloemveld sub-system for Vryheid – May decision month (DWS, 2013)**

- Klipfontein Dam sub-system:** The level of restrictions in the Klipfontein Dam depends largely on the water requirement imposed on the dam (combined requirement of the Vryheid WSS, Ulundi WSS, Mpungamhlope WSS as well as the irrigation between Klipfontein Dam and the Ulundi balancing weir). Based on the 12.78 million m<sup>3</sup>/annum estimated abstraction rate at the Ulundi balancing weir (2010), restrictions should be imposed on the dam as soon as it drops below  $\pm 50\%$  of Full Supply Capacity (**Figure 17.12**).

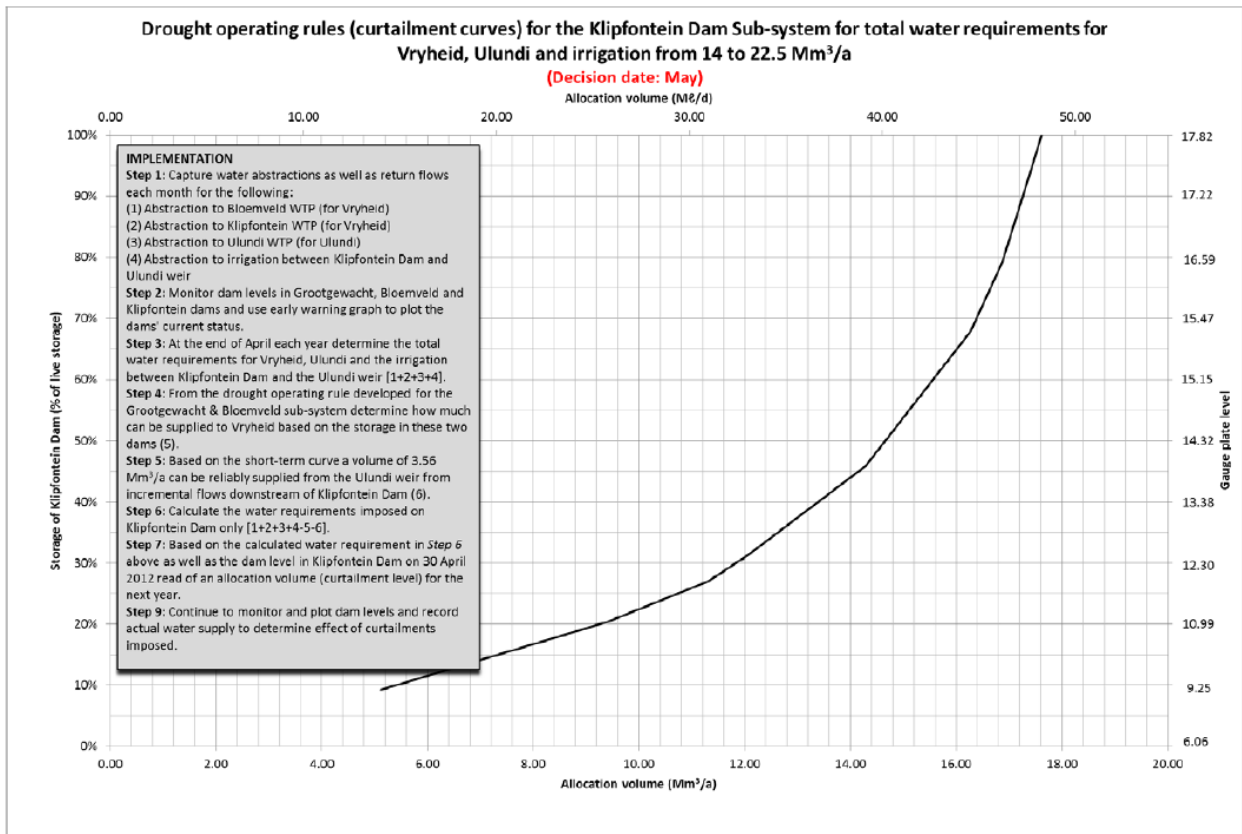

**Figure 17.12 Drought operating rule for Klipfontein Dam for Vryheid – May decision month (DWS: 2013)**

- Mvunyane Dam sub-system:** The Mvunyane Dam was over-allocated in 2010 and restrictions had to be imposed as soon as the dam dropped below 100% of its live storage capacity. During high flow periods, the systems was indirectly curtailed through infrastructure capacity constraints in the water delivery system which existed between the dam and the WTP. During dry periods additional curtailments would be needed. The system operators have to carefully monitor water supply and return flows from the eMondlo WSS, and use the drought operating rule developed to determine the allocatable volume each year (**Figure 17.13**).

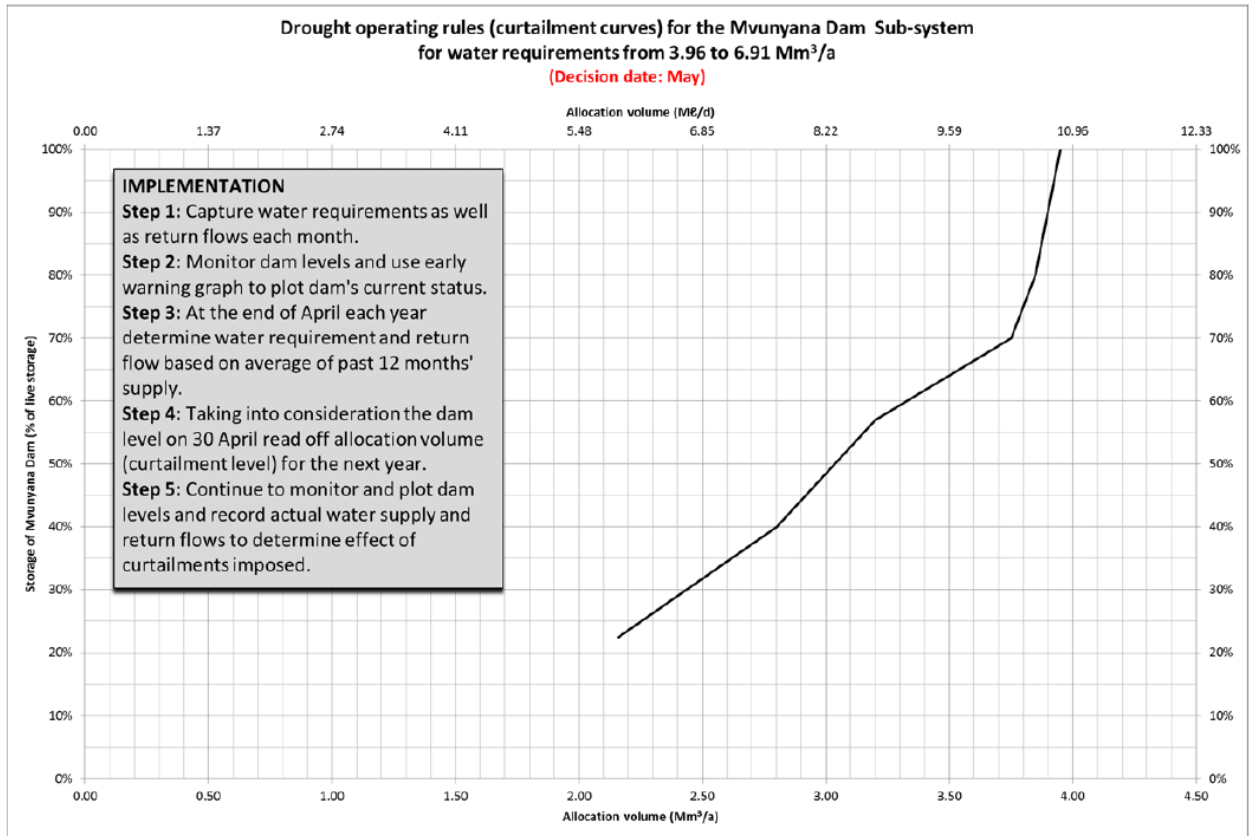

**Figure 17.13 Drought operating rule for Mvunyane Dam–May decision month (DWS: 2013)**

Drought operating rules and the levels at which curtailment of water supply should be initiated in the White Mfolozi River catchment depend on the water abstractions and return flows within the system. As such, water abstractions and water levels in the dams have to be monitored and recorded in order to successfully implement the developed drought operating rules.

The drought operating rules relate to water levels in the dams at the beginning of May, the decision month, and these allocate water via a simplified curve. A number of curves were developed to account for expected changes in water requirements and the expected return flows. These curves were developed for a five year period following from the year 2010. Actual water requirements and dam levels have to be used to determine the correct curve to use at the time of making a decision.

### **Black Mfolozi Water Supply Operating Rule**

The Nongoma WSS is supplied using water from the Vuna Dam situated in the Vuna River (a tributary of the Black Mfolozi River) and the Vokwana Dam situated in the Vokwana River, a tributary of the Vuna River. The storage capacity of the Vokwana Dam is 1.7 million m<sup>3</sup>.

The estimated historical yield of Vuna Dam is about 2.09 million m<sup>3</sup>/annum, assuming a 50% live storage. With the current water requirements estimated to be 8.30 Mℓ/d, the availability of a reliable water supply from the Vuna System is a limiting factor to meeting the current and future water requirements of the Nongoma WSS.

Another source of surface water supply is abstraction from a weir in the Mbila River. Water from this weir is supplied to the Embile Water Treatment Plant (WTP). This scheme supplements the water supply from the Vuna WTP and supplies the communities to the east of Nongoma town. The yield available is very limited and cannot meet the water requirements of the demand centre to the east of the Nongoma WSS.

The third source of surface water supply is the run-of-river abstraction from the Nkunzinkulu River, a tributary of the Kwanhlekiswa River. This supplies the Osingisingini WTP, which has a design capacity of 60 kℓ/d (DWS, 2015).

### **Nongoma Water Supply System Drought operating rules**

The operating rules specify that abstraction should first be from the Vuna Dam as it has the smaller storage capacity. This would occur mainly during the wet periods in order to take advantage of the large MAR from the Vuna River. When the flow in the Vuna River exceeds the abstraction capacity to the WTP, water is pumped into the Vokwana Dam, which acts as a pumped storage system. The historical firm yield of the system is 2.09 million m<sup>3</sup>/annum (5.73 Mℓ/day).

If the demand at the WTP exceeds the available flows in the Vuna River and the volume available in the Vuna Dam, then water is drawn from Vokwana Dam. This is normally during dry periods and in these instances, the Vuna and Vukwana Dams are likely to only supply a maximum of 5.5 Mℓ/day. The full 8.3 Mℓ/day WTP demand would then have to be curtailed to ensure that the dams do not deplete to dead storage. Without some form of water resource augmentation, the system will have to be placed on near permanent curtailments (based on the current demands) (DWS, 2015).

DWS (2015) recommends the implementation of water conservation and water demand management (WCWDM) measures to reduce water losses. Such interventions could potentially save approximately 1.1 Mℓ/d (DWS, 2015). Additional water supply from the Black Mfolozi River could also be investigated using the Vokwana Dam as the “off-channel storage dam”. In this scenario, the raising of the Vokwana Dam should also be investigated.

Drought operating rules presented as curtailment curves related to various states of Vokwana on the 1<sup>st</sup> of May are shown in **Figure 17.14**. It can be seen that the maximum target draft that can be allowed under the curtailment rules is 2.5 million m<sup>3</sup>/annum (6.8 Mℓ/day). The level of restrictions associated with each target draft, i.e. the volume allocated, are also shown. It is shown that as the storage level for the 2.5 million m<sup>3</sup>/annum target draft drops below 64%, the users are curtailed. The full target demand of 2.5 million m<sup>3</sup>/annum is only supplied for a very short period. If the target draft is 2.2 million m<sup>3</sup>/annum (6.0 Mℓ/day), curtailments are only implemented below 50% of full supply capacity, i.e. 0.86 million m<sup>3</sup> storage in Vokwana Dam.



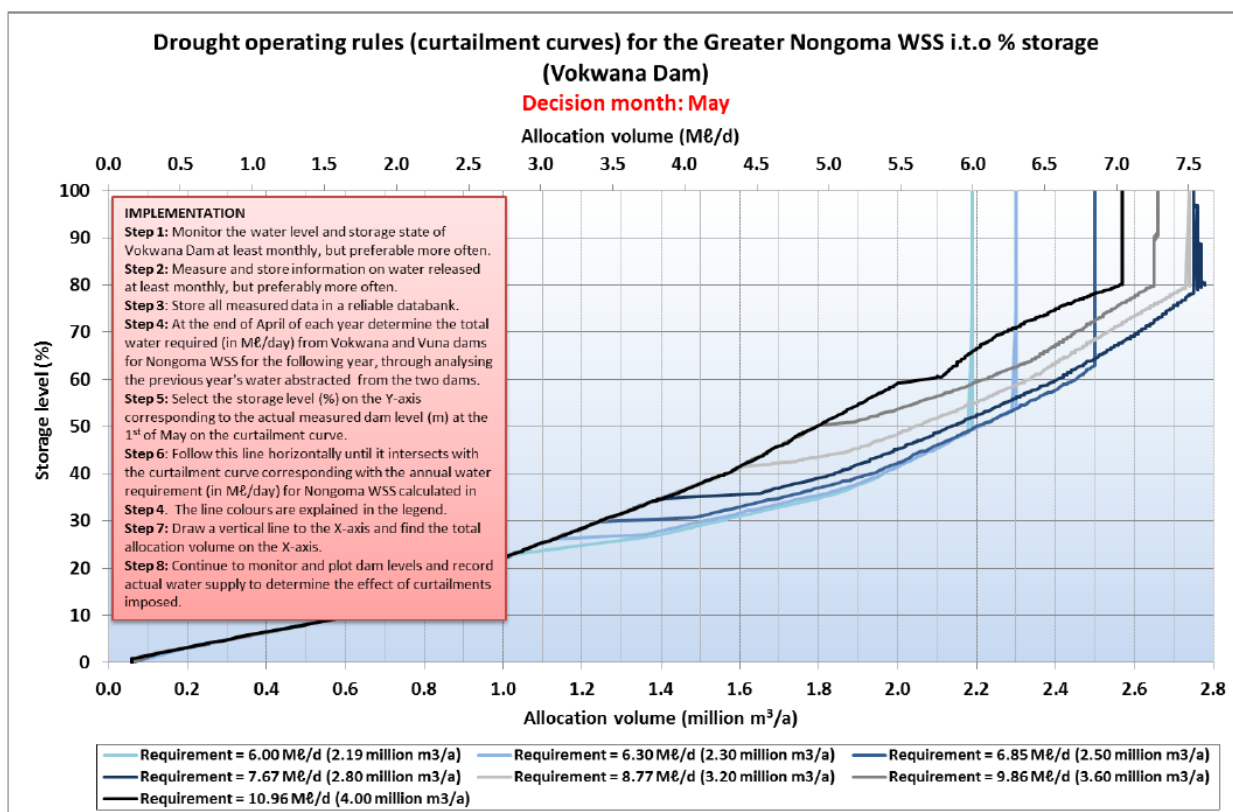

**Figure 17.14 Drought operating rule for Vokwana Dam–May decision month (DWA: 2013)**

## 17.3 Supply Systems

### 17.3.1 Description of the Mfolozi System

#### (a) Overview of the Mfolozi System

The Zululand DM is one of the 14 Water Services Authorities in the KwaZulu-Natal Province. The Zululand DM is located on the northern regions of the KwaZulu-Natal Province and covers an area of approximately 14 810 km<sup>2</sup>, is bounded by Swaziland and Mpumalanga Province on the north, Amajuba DM to the west, Umkhanyakude DM to the east and Umzinyathi and King Cetshwayo DMs to the south. Approximately half of the area is under the jurisdiction of traditional authorities while the remainder is divided between commercially owned farms and conservation areas. The District comprises the following five local municipalities as depicted in **Figure 17.15**:

- eDumbe (KZ 261)
- uPhongolo (KZ 262)
- Abaqulusi (KZ 263)
- Nongoma (KZ 265)
- Ulundi (KZ 266)



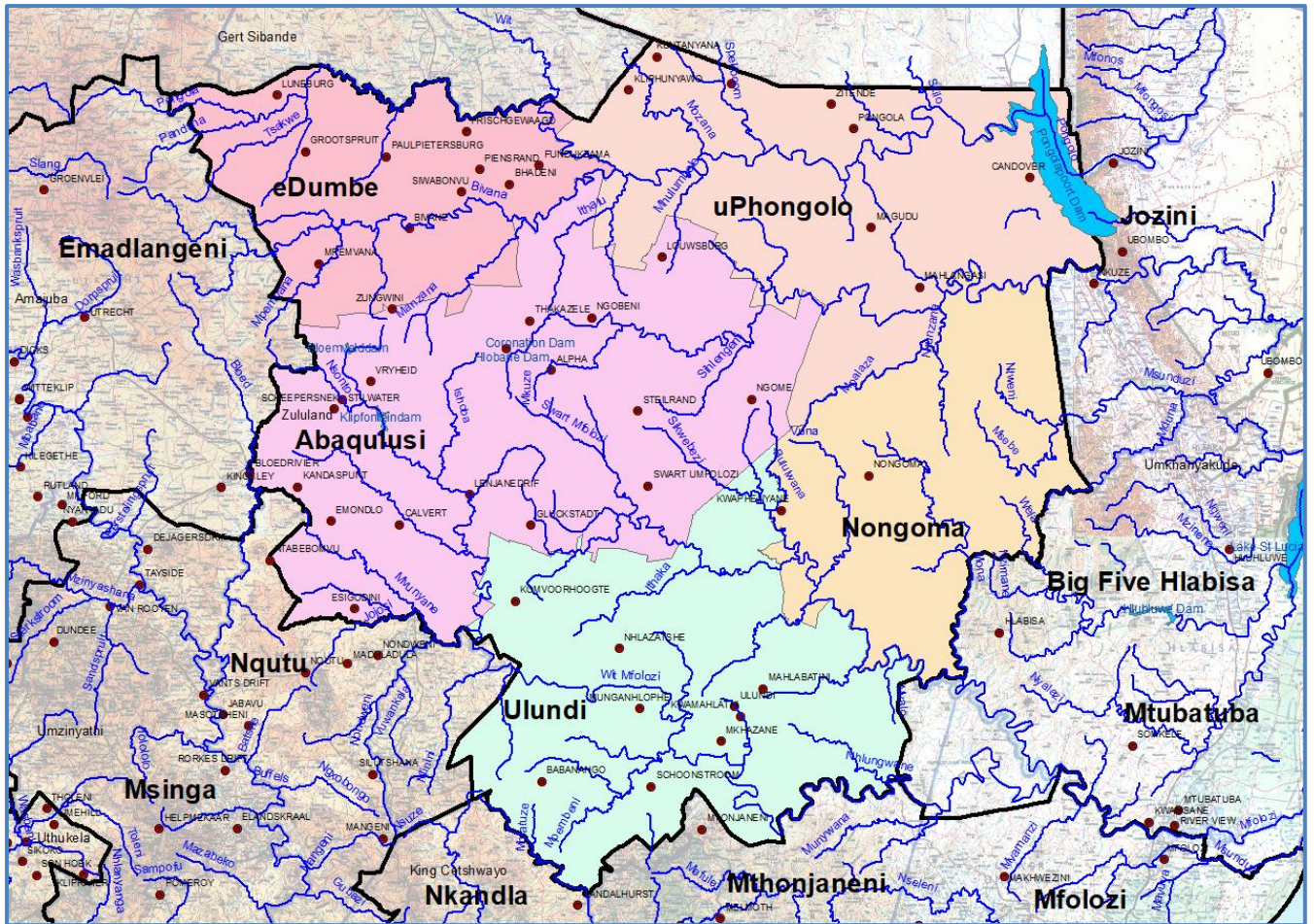

**Figure 17.15 Local Municipalities in Zululand District**

According to the Zululand DM WSDP 2014, the municipality falls within the Mfolozi, Mkuze and Pongola secondary catchments of the Usuthu/Mhlatuze Water Management Area (WMA). The aerial extent of the municipality occupies approximately 22% of this WMA.

This chapter will only describe the water supply systems, fed by the Mfolozi WMA and specifically water supply systems where the WTP is greater than or equal to 2 Ml/day. The Mfolozi Catchment consists of the White Mfolozi and the Black Mfolozi catchments. These catchments consist mostly of Traditional Authority land, with the main activity being cattle farming.

The three Local Municipalities, within the Zululand DM, that are being supplied from the White and Black Mfolozi WMA are, Abaqulusi (KZ 263), a portion of Nongoma (KZ 265) and Ulundi (KZ 266).

The Mfolozi WMA serves as a raw water resource for the following Bulk Water Supply Systems:

- Ulundi BWSS and Nkonjeni BWSS
- Vuna and Embile BWSS
- Mpugamhlophe BWSS
- Vryheid BWSS
- Usuthu/Enyonkeni BWSS
- Mondlo BWSS



## (b) Nkonjeni Regional Bulk Water Supply Scheme (Ulundi, Mpungamhlophe and Nkonjeni Water Treatment Plants)

The Ulundi WTP, Mpungamhlophe WTP and the Nkonjeni WTP are combined and known as the Nkonjeni Regional Bulk Water Supply Scheme (RBWSS).

The Nkonjeni RBWSS draws raw water from a weir on the White Mfolozi River (**Figure 17.16**), which is augmented from the Klipfontein Dam, situated in the White Mfolozi River. Water is directed from the river into a canal where it is further directed to a holding chamber. The water is then pumped (**Table 17.10**) up to the WTP (**Table 17.9**). The potable water is distributed via pipelines (**Table 17.12**) to two distribution reservoirs (**Table 17.11**), namely, Reservoir 1 and Reservoir 2. Potable water is then pumped via two booster pump stations to the Mashona Reservoir in the Nkonjeni area. From there, the potable water is supplied to the Nkonjeni Reservoir and the Mahlabathini Reservoir.

Potable water from Reservoir 2 is supplied to the terminal reservoirs, namely, Site Reservoir 1, Site Reservoir 2 and Site Reservoir 4.



**Figure 17.16** Aerial view of the weir and Ulundi Water Treatment Plant.

Ulundi WTP has a design capacity of 27 Mℓ/day and currently operates at an average of 22 Mℓ/day.

The characteristics of the Ulundi and Nkonjeni WTP's are shown in **Table 17.9**.

**Table 17.9 Characteristics of the Ulundi/Nkonjeni WTP's.**

<b>WTP Name:</b>	Ulundi WTP	Nkonjeni WTP
<b>System:</b>	Mfolozi Supply System	Mfolozi Supply System
<b>Maximum Design Capacity:</b>	27 Mℓ/day	300 kl/day Package Plant
<b>Current Utilisation:</b>	20 Mℓ/day	300 kℓ/day
<b>Raw Water Storage Capacity:</b>	0 Mℓ	0 MI
<b>Raw Water Supply Capacity:</b>	20 Mℓ/day	300 kℓ/day
<b>Pre-Oxidation Type:</b>	None	None
<b>Primary Water Pre-Treatment Chemical:</b>	Polymeric Coagulant	Polymeric Coagulant
<b>Total Coagulant Dosing Capacity:</b>	13 ℓ/hour (running at 50%)	13 l/hour (running at 50%)
<b>Rapid Mixing Method:</b>	Conventional Paddle Flash Mixer	Conventional Paddle Flash Mixer
<b>Clarifier Type:</b>	Sedimentation tanks	Dortmund manual clarifiers
<b>Number of Sedimentation Tanks:</b>	5	2
<b>Total Area of all Clarifiers:</b>	1225 m <sup>2</sup>	6.28 m <sup>2</sup>
<b>Total Capacity of Clarifiers:</b>	12.5 Mℓ/day	300 kℓ/day
<b>Filter Type:</b>	Constant Rate Rapid Gravity Filters	Pressure filter
<b>Number of Filters:</b>	6 (2 Old and 6 New)	1
<b>Filter Floor Type</b>	Laterals with Nozzles	Laterals with Nozzles
<b>Total Filtration Area of all Filters</b>	573.61m <sup>2</sup>	25 m <sup>2</sup>
<b>Total Filtration Design Capacity of all Filters:</b>	12.5 Mℓ/day	300 kl/day
<b>Total Capacity of Backwash Water Tanks:</b>	0m <sup>3</sup>	0m <sup>3</sup>
<b>Total Capacity of Sludge Treatment Plant:</b>	None	None
<b>Capacity of Used Washwater System:</b>	0 Mℓ/day	0 MI/day
<b>Primary Post Disinfection Type:</b>	Chlorine gas	Sodium Hypochlorite
<b>Disinfection Dosing Capacity:</b>	10 kg/hr Chlorinator	5 l NaOCl/hr
<b>Disinfectant Storage Capacity:</b>		
<b>Total Treated Water Storage Capacity:</b>	27 Mℓ	0.28 MI

The Nkonjeni WTP draws raw water from a nearby stream originating from the Nkonjeni Dam. A submersible pump located in the stream pumps the raw water to the WTP. Potable water is then pumped to the Nkonjeni Reservoir.

The Nkonjeni WTP is a 300 kl/day package plant, which was initially installed to supply the Nkonjeni hospital. The Nkonjeni area is mainly dependent on supply from the Ulundi WTP as described above.

**Figure 17.17** shows an aerial view of the Nkonjeni Dam and package plant.



**Figure 17.17** Aerial view of the Nkonjeni Dam and Nkonjeni Water Treatment Plant

**Figure 17.18** shows a schematic layout of the Ulundi WTP Supply System

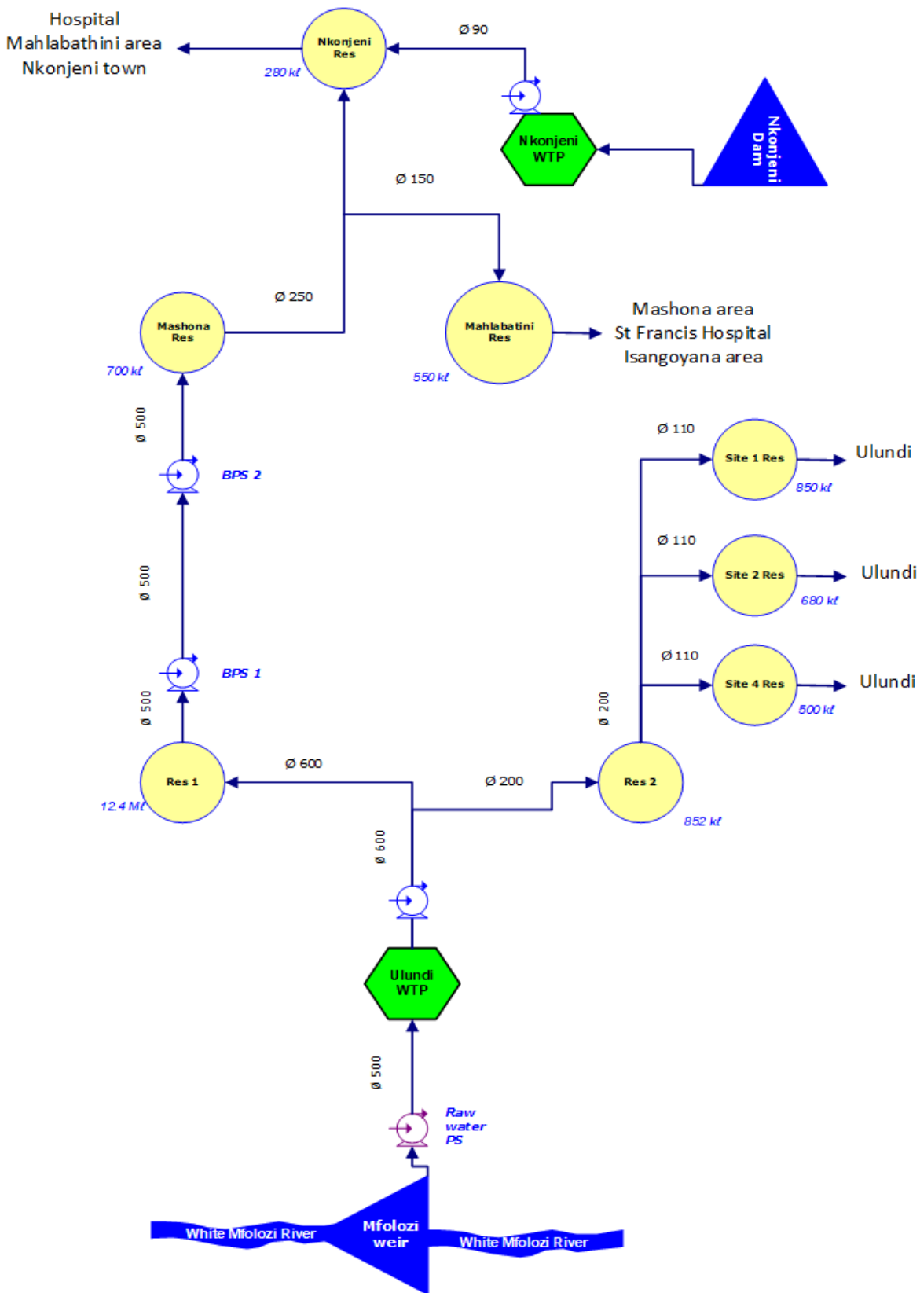

Figure 17.18 Schematic layout of the Ulundi WTP Supply System



**Table 17.10 Pump details: Ulundi/Nkonjeni Supply System**

System	Pump Station Name	Number of Pumps		Pump Description	Supply From	Supply To	Static Head (m)	Duty Head (m)	Duty Capacity (Mℓ/day)
		Number of Duty Pumps	Number of Standby Pumps						
	Raw water PS	3	1	SALWEIR : SDC 125-150	Raw water channel	Ulundi WTP	23	25**	9
Ulundi/Nkonjeni	Ulundi PS	1	1	KSB MTC A 125/2-10.2 10.167	Ulundi WTP	Res 1	195	230**	6.6
Ulundi/Nkonjeni	Ulundi PS	1	1	SULZER : HZ-151-7401	Ulundi WTP	Res 2	185	210	6.7
Ulundi/Nkonjeni	BPS 1	3	1	KSB WkLn 80/3	Res 1	BPS 2	154	160**	6.6
Ulundi/Nkonjeni	BPS 2	3	1	KSB WkLn 80/3	BPS 2	Mashona Res	146	155**	6.6
Ulundi/Nkonjeni	Nkonjeni PS	1	1	Ebara MD40-125/2.2	Nkonjeni WTP	Nkonjeni Res	105	110**	0.32

- \*\* These figures are based on calculated head loss

**Table 17.11 Reservoir details: Ulundi/Nkonjeni RBWSS.**

System	Reservoir Site	Reservoir Name	Capacity (Mℓ)	Function	TWL (aMSL)	FL (aMSL)
Ulundi/Nkonjeni	Ulundi/Nkonjeni	Res 1	6.6	Distribution	731	727*
Ulundi/Nkonjeni	Ulundi/Nkonjeni	Res 2	0.684	Distribution	684	679*
Ulundi/Nkonjeni	Ulundi/Nkonjeni	Mashona Res	0.700	Terminal	1031	1026*
Ulundi/Nkonjeni	Ulundi/Nkonjeni	Site Res 1	0.850	Terminal	1014	1011
Ulundi/Nkonjeni	Ulundi/Nkonjeni	Site Res 2	0.680	Terminal	820	817
Ulundi/Nkonjeni	Ulundi/Nkonjeni	Site Res 4	0.250	Terminal	511	506*
Ulundi/Nkonjeni	Ulundi/Nkonjeni	Nkonjeni Res	0.280	Terminal	976	972*
Ulundi/Nkonjeni	Ulundi/Nkonjeni	Mahlabathini Res	0.550	Terminal	845	841*

\*These figures are estimates and must be verified.

**Table 17.12 Pipeline details: Ulundi/Nkonjeni RBWSS.**

System	Pipeline Name	From	To	Length (km)	Nominal Diameter (mm)	Material	Capacity (Ml/day)	Age (years)
Ulundi/Nkonjeni	Raw water pipeline	Raw Water PS	Ulundi WTP	0.234	500	Steel	25.446**	42#
Ulundi/Nkonjeni	Potable water pipeline	Ulundi WTP	Res 1	1.758	600	Steel	36.6**	42
Ulundi/Nkonjeni	Potable water pipeline	Ulundi WTP	Res 2	4.461	600/200	Steel/uPVC	4.07**	42
Ulundi/Nkonjeni	Potable water pipeline	Res 1	BPS 2	4.37	500	Steel	25.446**	42
Ulundi/Nkonjeni	Potable water pipeline	BPS 2	Mashona Res	2.097	500	Steel	25.446**	42
Ulundi/Nkonjeni	Potable water pipeline	Res 2	Site Res 1	6.234	110	uPVC	1.6*	42
Ulundi/Nkonjeni	Potable water pipeline	Res 2	Site Res 2	1.384	110	uPVC	1.6*	42
Ulundi/Nkonjeni	Potable water pipeline	Res 2	Site Res 4	6.682	110	uPVC	1.6*	42
Ulundi/Nkonjeni	Potable water pipeline	Mashona Res	Nkonjeni Res	6.552	90	uPVC	0.82*	42
Ulundi/Nkonjeni	Potable water pipeline	Mashona Res	Mahlabathini Res	13.037	150	uPVC	3.05*	42

\* Based on a velocity of 2 m/s      \*\* Based on a velocity of 1.5 m/s    # Age need to be verified

The Mpungamhlope WTP (**Figure 17.19, Table 17.13**), a package plant with a design capacity of 1.9 Mℓ/day, draws raw water from the White uMfolozi River which is adjacent to the treatment works. A submersible pump abstracts raw water from the river and pumps this into a raw water storage chamber via a flow meter.

From the WTP, potable water is pumped (**Table 17.14**) through a rising main (**Table 17.16**) to two Command Reservoirs (**Table 17.15**) from where it is distributed to the community (**Figure 17.20**).

**Figure 17.19** shows an aerial view of the Mpungamhlope Package Plant



**Figure 17.19** An Aerial view of the Mpungamhlope WTP (Google Earth 2020: website).



**Table 17.13 Characteristics of the Mpungamhlope WTP**

<b>WTP Name:</b>	Mpungamhlope WTP
<b>System:</b>	Mfolozi Supply System
<b>Maximum Design Capacity:</b>	1.9 Mℓ/day
<b>Current Utilisation:</b>	1.9 Mℓ/day
<b>Raw Water Storage Capacity:</b>	0 Mℓ
<b>Raw Water Supply Capacity:</b>	1.9 Mℓ/day
<b>Pre-Oxidation Type:</b>	None
<b>Primary Water Pre-Treatment Chemical:</b>	Polymeric Coagulant
<b>Total Coagulant Dosing Capacity:</b>	2 ℓ/hour
<b>Rapid Mixing Method:</b>	Conventional Paddle Flash Mixer
<b>Clarifier Type:</b>	Manual Clarifiers
<b>Number of Clarifiers:</b>	6
<b>Total Area of all Clarifiers:</b>	63.61 m <sup>2</sup>
<b>Total Capacity of Clarifiers:</b>	1.9 Mℓ/day
<b>Filter Type:</b>	Pressure filters
<b>Number of Filters:</b>	3
<b>Filter Floor Type</b>	
<b>Total Filtration Area of all Filters</b>	5.3 m <sup>2</sup>
<b>Total Filtration Design Capacity of all Filters:</b>	1.9 Mℓ/day
<b>Total Capacity of Backwash Water Tanks:</b>	0m <sup>3</sup>
<b>Total Capacity of Sludge Treatment Plant:</b>	None
<b>Capacity of Used Washwater System:</b>	0 Mℓ/day
<b>Primary Post Disinfection Type:</b>	Chlorine gas
<b>Disinfection Dosing Capacity:</b>	10 kg/hr Chlorinator
<b>Disinfectant Storage Capacity:</b>	
<b>Total Treated Water Storage Capacity:</b>	2 Mℓ

Figure 17.20 shows schematic of the Mpungamhlope Supply System

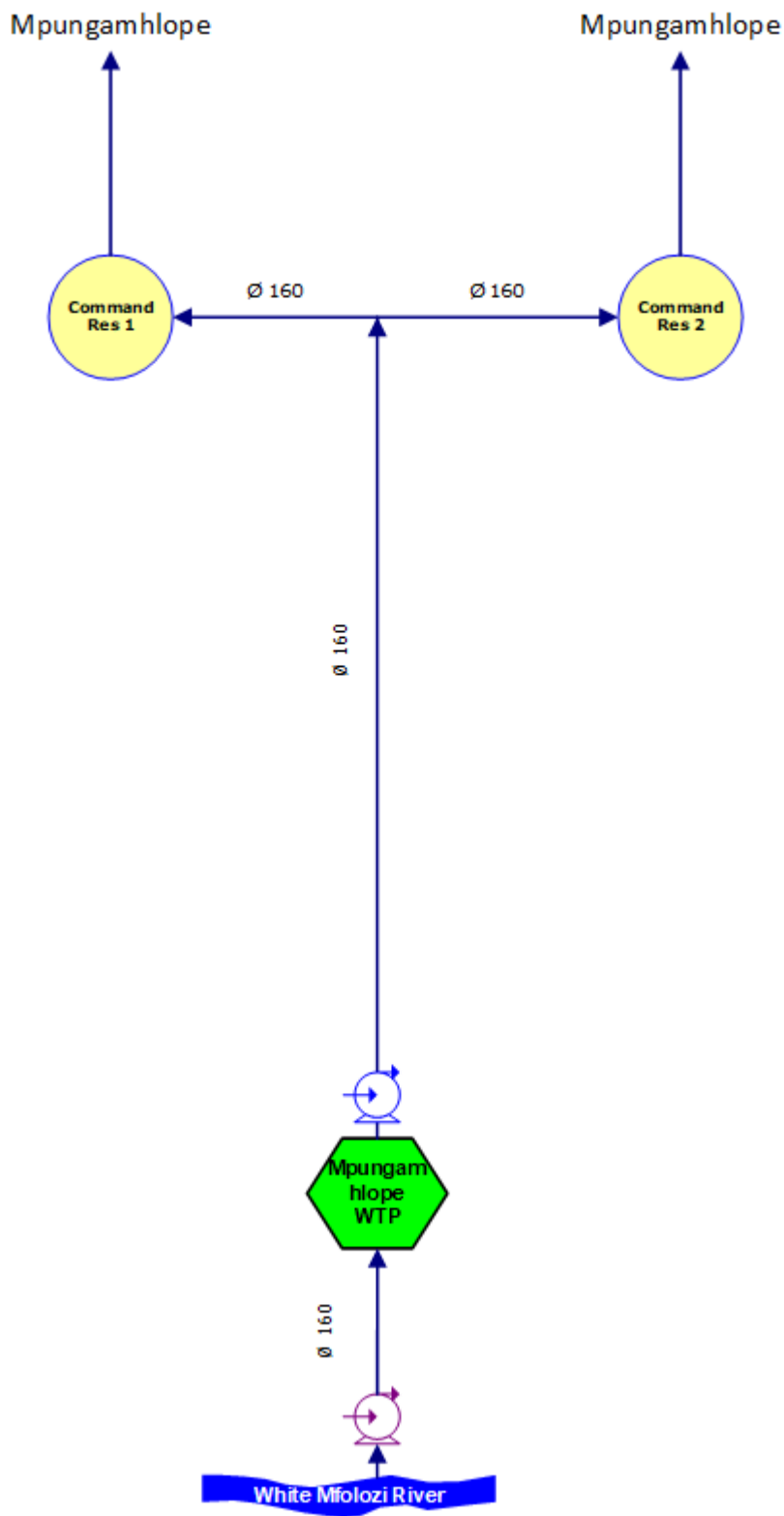

Figure 17.20 Schematic of the Mpungamhlope Supply System

**Table 17.14 Pump details: Mpungamhlope Supply System**

System	Pump Station Name	Number of Pumps		Pump Description	Supply From	Supply To	Static Head (m)	Duty Head (m)	Duty Capacity (Mℓ/day)
		Number of Duty Pumps	Number of Standby Pumps						
Mpungamhlope	Raw water PS	1	0	Xylem 7.5hp	Raw water channel	Mpungamhlope WTP	8	15**	1
Mpungamhlope	Vuna PS	2	2	Franklin -Mono HD 115H Mk2	Mpungamhlope WTP	Command Res 1 & 2	154	170**	1

- \*\* These figures are based on calculated head loss

**Table 17.15 Reservoir details: Mpungamhlope BWSS.**

System	Reservoir Site	Reservoir Name	Capacity (Mℓ)	Function	TWL (aMSL)	FL (aMSL)
Mpungamhlope	Mpungamhlope	Command Res 1	1.0	Distribution	764	761*
Mpungamhlope	Mpungamhlope	Command Res 2	0.2	Distribution	764	761*

\*These figures are estimates and must be verified

**Table 17.16 Pipeline details: Mpungamhlope BWSS.**

System	Pipeline Name	From	To	Length (km)	Nominal Diameter (mm)	Material	Capacity (Mℓ/day)	Age (years)
Mpungamhlope	Raw water pipeline	Raw Water PS	Mpungamhlope WTP	0.070	160	uPVC	2.6**	41#
Mpungamhlope	Raw water pipeline	Mpungamhlope WTP	Command Res 1	3.074	160	uPVC	2.6**	41#
Mpungamhlope	Potable water pipeline	Mpungamhlope WTP	Command Res 2	3.074	160	uPVC	2.6**	41#

Based on a velocity of 2 m/s

\*\* Based on a velocity of 1.5 m/s # Age need to be verified

### (c) Usuthu Regional Bulk Water Supply Scheme (RBWSS)

The Usuthu RBWSS is the largest water supply scheme in the Zululand District and supplies almost the entire Nongoma LM and also represents the biggest portion of the backlogs.

The Usuthu RBWSS is a combination of three bigger (>2MI/day) water treatment plants and two smaller (<2MI/day) WTP's namely:

- Vuna WTP (4.5 MI/day)
- Usuthu WTP (20 MI/day)
- Ceza WTP (3 MI/day)
- Thulasizwe WTP (0.16 MI/day)
- Osingisingini WTP (0.04 MI/day)

This section will only consider the first three WTP's

The Usuthu WTP (**Figure 17.21, Table 17.17**), a package plant with a design capacity of 4.0 Mℓ/day and upgraded in 2016 to 20 MI/day, draws raw water from a weir on the Black uMfolozi River adjacent to the treatment works. A submersible pump abstracts raw water from the river and pumps this to a raw water storage chamber.

From the WTP, potable water is pumped (**Table 17.18**) through a rising main (**Table 17.20**) to the Mjeni Balancing Tank (**Table 17.19**) from where it is distributed to the community (**Figure 17.22**).

**Figure 17.21** shows an aerial view of the Usuthu WTP.



**Figure 17.21** An Aerial view of the Usuthu WTP (Google Earth 2020: website).



**Table 17.17 Characteristics of the Usuthu/Enyonkeni WTP's.**

WTP Name:	Usuthu WTP	Enyonkeni WTP
System:	Mfolozi Supply System	Mfolozi Supply System
Maximum Design Capacity:	20 Mℓ/day	300 kℓ/day
Current Utilisation:	18 Mℓ/day	300 kℓ/day
Raw Water Storage Capacity:	0 Mℓ	0 MI
Raw Water Supply Capacity:	20 Mℓ/day	300 kℓ/day
Pre-Oxidation Type:	None	None
Primary Water Pre-Treatment Chemical:	Polymeric Coagulant	Polymeric Coagulant
Total Coagulant Dosing Capacity:	5 ℓ/hour	3 ℓ/hour
Rapid Mixing Method:	Conventional Paddle Flash Mixer	Conventional Paddle Flash Mixer
Clarifier Type:	Manual Clarifiers	Manual Clarifiers
Number of Sedimentation Tanks:	8	2
Total Area of all Clarifiers:	66 m <sup>2</sup>	12.48 m <sup>2</sup>
Total Capacity of Clarifiers:	20 Mℓ/day	300 kl/day
Filter Type:	Pressure Filters	Pressure Filters
Number of Filters:	8	4
Filter Floor Type	Laterals with Nozzles	Laterals with Nozzles
Total Filtration Area of all Filters	28 m <sup>2</sup>	4.56 m <sup>2</sup>
Total Filtration Design Capacity of all Filters:	20 Mℓ/day	300 kℓ/day
Total Capacity of Backwash Water Tanks:	0m <sup>3</sup>	0m <sup>3</sup>
Total Capacity of Sludge Treatment Plant:	None	None
Capacity of Used Washwater System:	0 Mℓ/day	0 Mℓ/day
Primary Post Disinfection Type:	Chlorine gas	Sodium Hypochlorite
Disinfection Dosing Capacity:	10 kg/hr Chlorinator	5 l NaOCl/hr
Disinfectant Storage Capacity:		
Total Treated Water Storage Capacity:	12 Mℓ	0.28 MI

Figure 17.22 shows schematic of the Usuthu Supply System

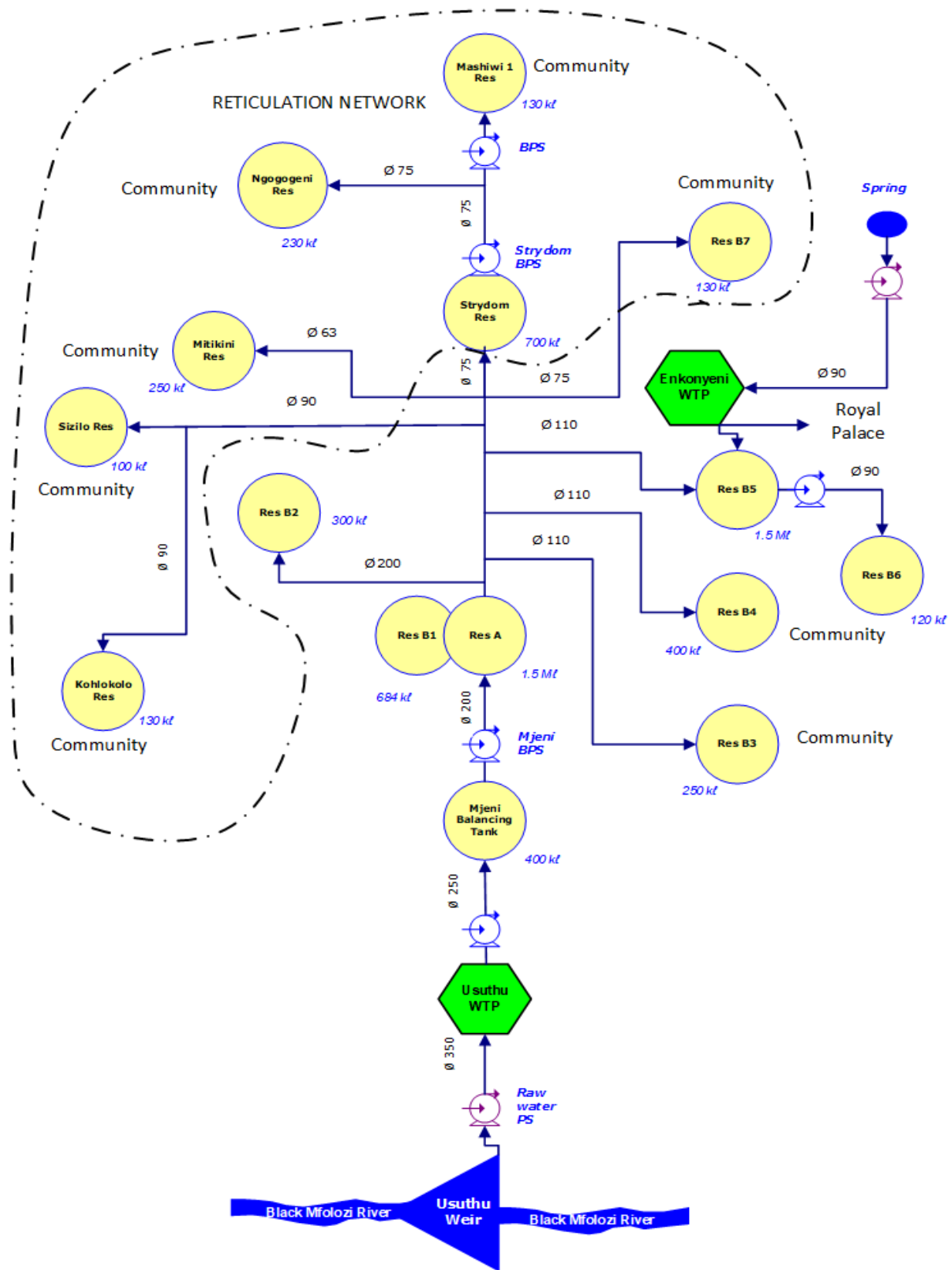

Figure 17.22 Schematic of the Usuthu Supply System

**Table 17.18 Pump details: Usuthu Supply System**

System	Pump Station Name	Number of Pumps		Pump Description	Supply From	Supply To	Static Head (m)	Duty Head (m)	Duty Capacity (Mℓ/day)
		Number of Duty Pumps	Number of Standby Pumps						
Usuthu	Raw water PS	2	1	KSB LCC 150-500.3	Raw water channel	Usuthu WTP	11	15**	8
Usuthu	Nongoma HL PS	2	1	KSB WKLn 150/6	Usuthu WTP	Mahlombe PS	220	280**	6.912
Usuthu	Mahlombe PS	2	4	KSB WKLn 150/5	Nongoma HL PS	Vuna WTP	202	230**	6.912
Usuthu BWSS	Mjeni HL PS	3	1	KSB WKLn 65/4	Usuthu WTP	Mjeni PS	146	165	1.56
Usuthu	Mjeni PS	3	1	KSB WKLn 65/4	Mjeni HL PS	Mjeni Reservoir	162	180**	2.04
Usuthu BWSS	Mahhashini PS1	2	1	KSB WKLn 65/4	Mjeni Reservoir	Mahhashini PS2	150	180	1.5

- \*\* These figures are based on calculated head loss

**Table 17.19 Reservoir details: Usuthu BWSS.**

System	Reservoir Site	Reservoir Name	Capacity (Mℓ)	Function	TWL (aMSL)	FL (aMSL)
Usuthu	Usuthu	Mjeni Res	2.0	Balancing	401	397*
Usuthu	Usuthu	Res A	2.0	Distribution	536	532*
Usuthu	Usuthu	Res B1	0.5	Terminal	534	531*
Usuthu	Usuthu	Res B2	0.2	Terminal	515	512*

Usuthu	Usuthu	Res B3	0.3	Terminal	497	494*
Usuthu	Usuthu	Res B4	0.3	Terminal	467	464*
Usuthu	Usuthu	Res B5	1.5	Distribution	494	491*
Usuthu	Usuthu	Res B6	0.1	Terminal	498	495*

\*These figures are estimates and must be verified

**Table 17.20 Pipeline details: Usuthu BWSS.**

System	Pipeline Name	From	To	Length (km)	Nominal Diameter (mm)	Material	Capacity (Mℓ/day)	Age (years)
Usuthu	Raw water pipeline	Raw Water PS	Usuthu WTP	0.070	350	Steel	12.46**	42
Usuthu	Raw water pipeline	Usuthu WTP	Mjeni Balancing Tank	2.486	250	Steel	6.36**	42
Usuthu	Potable water pipeline	Mjeni Balancing Tank	Res A and B1	0.876	200	Steel	6.36**	42
Usuthu	Potable water pipeline	Res A	Res B2	2.291	200	Steel	6.36	42
Usuthu	Potable water pipeline	Res A	Res B3	8.171	200/110	mPVC	1.64*	42
Usuthu	Potable water pipeline	Res A	1Res B4	8.144	200/110	mPVC	1.64*	42
Usuthu	Potable water pipeline	Res A	Res B5	10.544	200/110	mPVC	1.64*	42
Usuthu	Raw water pipeline	Raw water PS	Enyonkeni WTP	1.5	90	uPVC	0.082**	42
Usuthu	Potable water pipeline	Enyonkeni WTP	Res B5 and the Palace	0.057	90	uPVC	0.082**	42

Based on a velocity of 2 m/s

\*\* Based on a velocity of 1.5 m/s # Age need to be verified



Vuna WTP (**Table 17.21**) is located approximately 12 km southwest of the town of Nongoma and supplies potable water to Nongoma and the neighbouring rural settlements in Vuna. Vuna WTP, with a capacity of 5 Ml/day, obtains its raw water from the Vuna and Vokwane Dams where it is treated at the WTP. From the WTP, potable water is pumped (**Table 17.22**) via a rising main (**Table 17.24**) to the Holinyoka BPS and then to the Lindizwe BPS and further boosted to the FM Tower Reservoir (**Table 17.23**). From there, it is gravity fed to the White City Reservoir and Canaan Pump Station and finally to the Elevated Reservoir where it supplies different parts of Nongoma (**Figure 17.25**).

The capacity of the system is supplemented by the Embile WTP (**Figure 17.24**), which obtains its raw water from the Embile Dam.

**Figure 17.23** shows an aerial view of the Vuna WTP and the Vuna Dam.

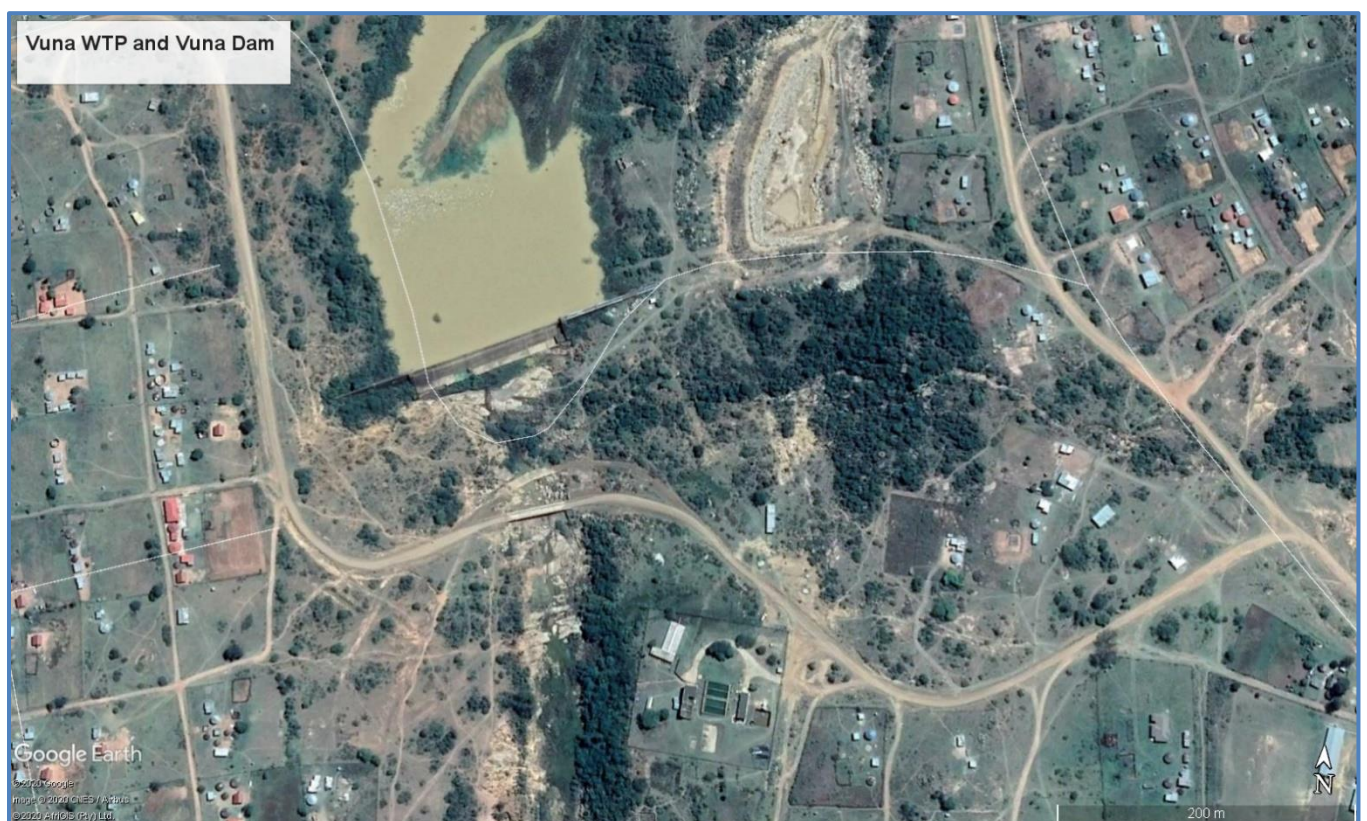

**Figure 17.23** An Aerial view of the Vuna WTP and the Vuna Dam (Google Earth 2020: website).

**Figure 17.24** shows an aerial view of the Embile WTP and the Embile Dam



Figure 17.24 An Aerial view of the Embile WTP and the Embile Dam (Google Earth 2020: website).

**Table 17.21 Characteristics of the Vuna/Embile WTP's.**

<b>WTP Name:</b>	Vuna WTP	Embile WTP
<b>System:</b>	Mfolozi Supply System	Mfolozi Supply System
<b>Maximum Design Capacity:</b>	5 Mℓ/day	500 kℓ/day
<b>Current Utilisation:</b>	4.5 Mℓ/day	500 kℓ/day
<b>Raw Water Storage Capacity:</b>	0 Mℓ	0 MI
<b>Raw Water Supply Capacity:</b>	5 Mℓ/day	300 kl/day
<b>Pre-Oxidation Type:</b>	None	None
<b>Primary Water Pre-Treatment Chemical:</b>	Polymeric Coagulant	Polymeric Coagulant
<b>Total Coagulant Dosing Capacity:</b>	13 ℓ/hour (running at 50%)	13 l/hour (running at 50%)
<b>Rapid Mixing Method:</b>	Conventional Paddle Flash Mixer	Conventional Paddle Flash Mixer
<b>Clarifier Type:</b>	Sedimentation tanks	Sedimentation Tanks
<b>Number of Sedimentation Tanks:</b>	4	2
<b>Total Area of all Clarifiers:</b>	336.36 m <sup>2</sup>	35.12 m <sup>2</sup>
<b>Total Capacity of Clarifiers:</b>	5 Mℓ/day	300 kl/day
<b>Filter Type:</b>	Constant Rate Rapid Gravity Filters	Pressure filter
<b>Number of Filters:</b>	3	4
<b>Filter Floor Type</b>	Laterals with Nozzles	Laterals with Nozzles
<b>Total Filtration Area of all Filters</b>	51.74 m <sup>2</sup>	5.35 m <sup>2</sup>
<b>Total Filtration Design Capacity of all Filters:</b>	5 Mℓ/day	500 kℓ/day
<b>Total Capacity of Backwash Water Tanks:</b>	0m <sup>3</sup>	0m3
<b>Total Capacity of Sludge Treatment Plant:</b>	None	None
<b>Capacity of Used Washwater System:</b>	0 Mℓ/day	0 MI/day
<b>Primary Post Disinfection Type:</b>	Chlorine gas	Sodium Hypochlorite
<b>Disinfection Dosing Capacity:</b>	10 kg/hr Chlorinator	5 l NaOCl/hr
<b>Disinfectant Storage Capacity:</b>		
<b>Total Treated Water Storage Capacity:</b>	27 Mℓ	0.28 MI

Figure 17.25 shows schematic of the Vuna/Embile Supply System.



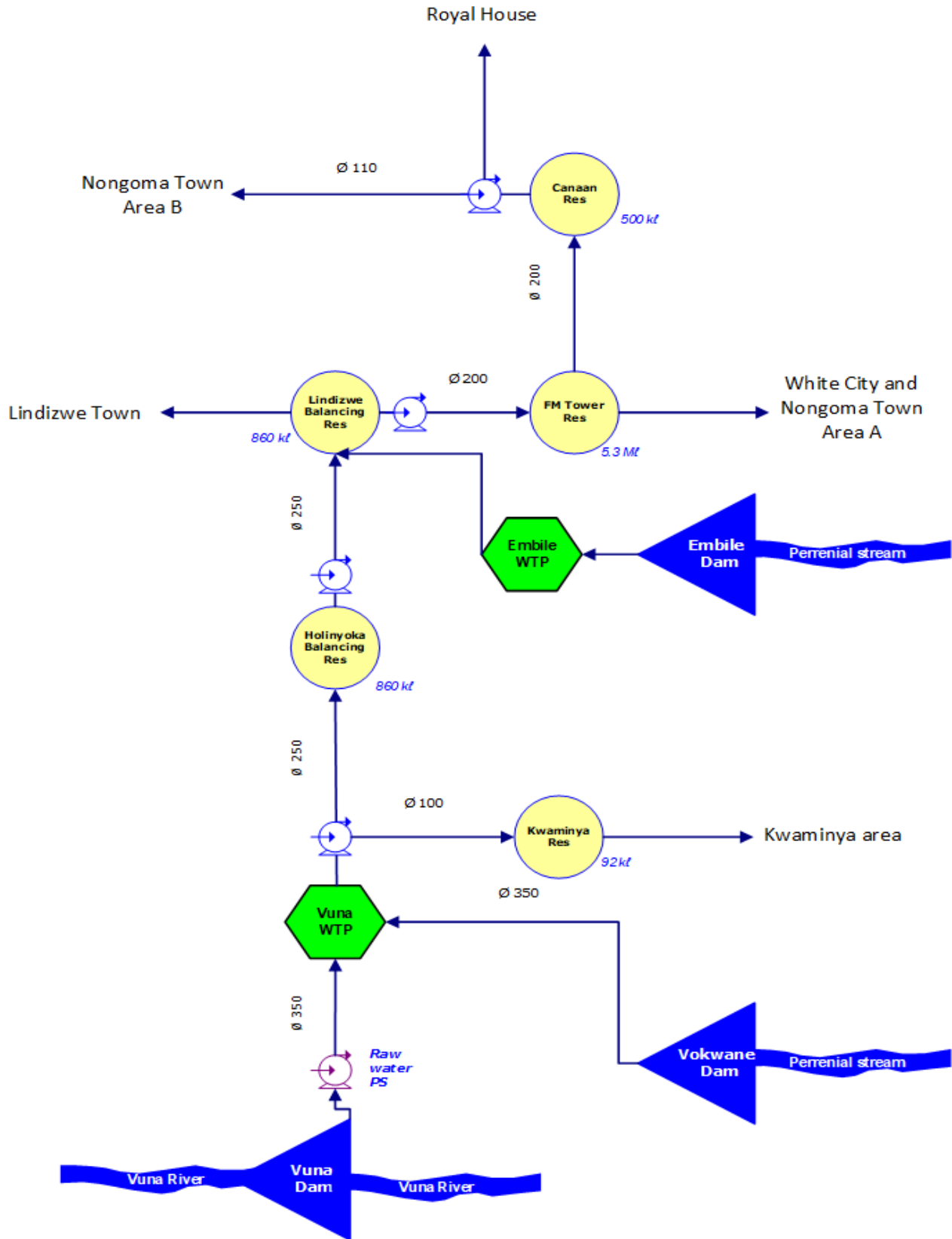

Figure 17.25 Schematic of the Vuna/Embile Supply System



**Table 17.22 Pump details: Vuna/Embile Supply System**

System	Pump Station Name	Number of Pumps		Pump Description	Supply From	Supply To	Static Head (m)	Duty Head (m)	Duty Capacity (Mℓ/day)
		Number of Duty Pumps	Number of Standby Pumps						
Vuna/Embile	Raw water PS	3	1		Raw water channel	VunaWTP	23	25**	9
Vuna/Embile	Vuna HL PS	2	1	SAMCO PUMPS LTF 100-125/9	Vuna WTP	Holinyonka Res	171	180**	9
Vuna/Embile	Holinyonka BPS	2	1	SAMCO PUMPS LTF 100-125/9	Holinyonka Res	Lindizwe Res	154	160**	8
Vuna/Embile	Lindizwe BPS	2	1	SAMCO PUMPS M10 VTLC 11 STAGE	Lindizwe Res	FM Tower Res	146	155**	8
Vuna/Embile	CanaanPS	1	1	Cemo Pumps HP 115& MONO HD155M	FM Tower Res	Nongoma Town and Royal House	105	110**	0.32

- \*\* These figures are based on calculated head loss

**Table 17.23 Reservoir details: Vuna/Embile BWSS.**

System	Reservoir Site	Reservoir Name	Capacity (Mℓ)	Function	TWL (aMSL)	FL (aMSL)
Vuna/Embile	Vuna/Embile	Holinyonka Res	1.0	Distribution	731	727*
Vuna/Embile	Vuna/Embile	Lindizwe Res	1.0	Distribution	684	679*
Vuna/Embile	Vuna/Embile	Kwaminya Res	0.092	Terminal	1031	1026*
Vuna/Embile	Vuna/Embile	FM Tower Res	5.3	Distribution	1014	1011
Vuna/Embile	Vuna/Embile	Canaan Res	0.2	Terminal	820	817

\*These figures are estimates and must be verified

**Table 17.24 Pipeline details: Vuna/EmBILE BWSS.**

System	Pipeline Name	From	To	Length (km)	Nominal Diameter (mm)	Material	Capacity (ML/day)	Age (years)
Vuna/EmBILE	Raw water pipeline	Raw Water PS	Vuna WTP	0.355	350	Steel	12.46**	42
Vuna/EmBILE	Raw water pipeline	Vokwane Dam	Vuna WTP	2.038	350	Steel	16.62*	42
Vuna/EmBILE	Potable water pipeline	Vuna WTP	Holinyonka Res	6.843	250	Steel	6.36**	42
Vuna/EmBILE	Potable water pipeline	Holinyonka Res	Lindizwe Res	3.687	250	Steel	6.36**	42
Vuna/EmBILE	Potable water pipeline	Lindizwe Res	FM Tower Res	4.297	200	Steel	4.07**	42
Vuna/EmBILE	Potable water pipeline	FM Tower Res	Canaan Res	3.175	200	uPVC	5.42*	42
Vuna/EmBILE	Potable water pipeline	Vuna WTP	Kwaminya Res	5.351	100	Steel	1.01**	42

\* Based on a velocity of 2 m/s      \*\* Based on a velocity of 1.5 m/s      # Age need to be verified

## (d) Hlahlindlela Regional Bulk Water Supply System (RBWSS)

The Hlahlindlela RBWSS supplies water to communities within the AbaQulusi LM. The Hlahlindlela RBWSS consist of two water supply schemes namely:

- Vryheid Water Supply Scheme
- eMondlo Water Supply Scheme

Vryheid BWSS consists of two WTP's (**Figure 17.28**), namely the 7.5 Mℓ/day Bloemveld WTP (**Figure 17.26**) and the 16 Mℓ/day Klipfontein WTP (**Figure 17.27**) (**Table 17.25**). Both these WTP's source raw water from the White Mfolozi River via the Bloemveld Dam and the Klipfontein Dam respectively.

### a) Bloemveld WTP

The Bloemveld WTP is located about 15km west of the town of Vryheid and is between Paulpietersburg and Vryheid in Zululand DM.

The Bloemveld WTP receives raw water from the Bloemveld Dam with the aid of abstraction pumps located at the dam. The water treatment process begins as soon as the raw water enters the treatment plant.



**Figure 17.26** An Aerial view of the Bloemveld WTP (Google Earth 2020: website).

### b) Klipfontein WTP

The Klipfontein WTP is located south of the town of Vryheid in Zululand District DM. The WTP primarily receives raw water that is pumped from the Klipfontein Dam. Raw water is also supplemented from the Bloemveld Dam when needed. The two dams work hand-in-hand to supply the town of Vryheid and surrounding areas with water through a series of pump stations (**Table 17.26**), pipelines (**Table 17.27**) and reservoirs (**Table 17.28**). Located at each dam is a pump station that pumps the water to the WTP. The water treatment process begins as soon as the raw water enters the treatment plant.



**Figure 17.27** An Aerial view of the Klipfontein WTP (Google Earth 2020: website).

**Table 17.25 Characteristics of the Bloemveld/Klipfontein WTP's.**

<b>WTP Name:</b>	Bloemveld WTP	Klipfontein WTP
<b>System:</b>	Mfolozi Supply System	Mfolozi Supply System
<b>Maximum Design Capacity:</b>	7.5 Mℓ/day	16 Mℓ/day
<b>Current Utilisation:</b>	7.5 Mℓ/day	16 Mℓ/day
<b>Raw Water Storage Capacity:</b>	0 Mℓ	0 MI
<b>Raw Water Supply Capacity:</b>	7.5 Mℓ/day	17 Mℓ/day
<b>Pre-Oxidation Type:</b>	None	None
<b>Primary Water Pre-Treatment Chemical:</b>	Polymeric Coagulant	Polymeric Coagulant
<b>Total Coagulant Dosing Capacity:</b>	13 ℓ/hour	13 ℓ/hour
<b>Rapid Mixing Method:</b>	Conventional Paddle Flash Mixer	Conventional Paddle Flash Mixer
<b>Clarifier Type:</b>	Dortmund Manual Clarifiers	Dortmund Manual Clarifiers
<b>Number of Clarifiers:</b>	5 (3 rectangular and 2 circular)	4 circular bridge clarifiers
<b>Total Area of all Clarifiers:</b>	579.98 m <sup>2</sup>	1844.34 m <sup>2</sup>
<b>Total Capacity of Clarifiers:</b>	7.5 Mℓ/day	16 Mℓ/day
<b>Filter Type:</b>	Gravity Sand Filters	Gravity Sand Filters
<b>Number of Filters:</b>	11	12
<b>Filter Floor Type</b>	Laterals with Nozzles	Laterals with Nozzles
<b>Total Filtration Area of all Filters</b>	222.21 m <sup>2</sup>	499.56 m <sup>2</sup>
<b>Total Filtration Design Capacity of all Filters:</b>	7.5 Mℓ/day	16 Mℓ/day
<b>Total Capacity of Backwash Water Tanks:</b>	0m <sup>3</sup>	0m <sup>3</sup>
<b>Total Capacity of Sludge Treatment Plant:</b>	None	None
<b>Capacity of Used Washwater System:</b>	0 Mℓ/day	0 MI/day
<b>Primary Post Disinfection Type:</b>	Chlorine gas	Chlorine gas
<b>Disinfection Dosing Capacity:</b>	10 kg/hr Chlorinator	10 kg/hr Chlorinator
<b>Disinfectant Storage Capacity:</b>		
<b>Total Treated Water Storage Capacity:</b>	13 Mℓ	13 MI

Figure 17.28 shows a schematic of the integration of the two WTP's and the supply system.



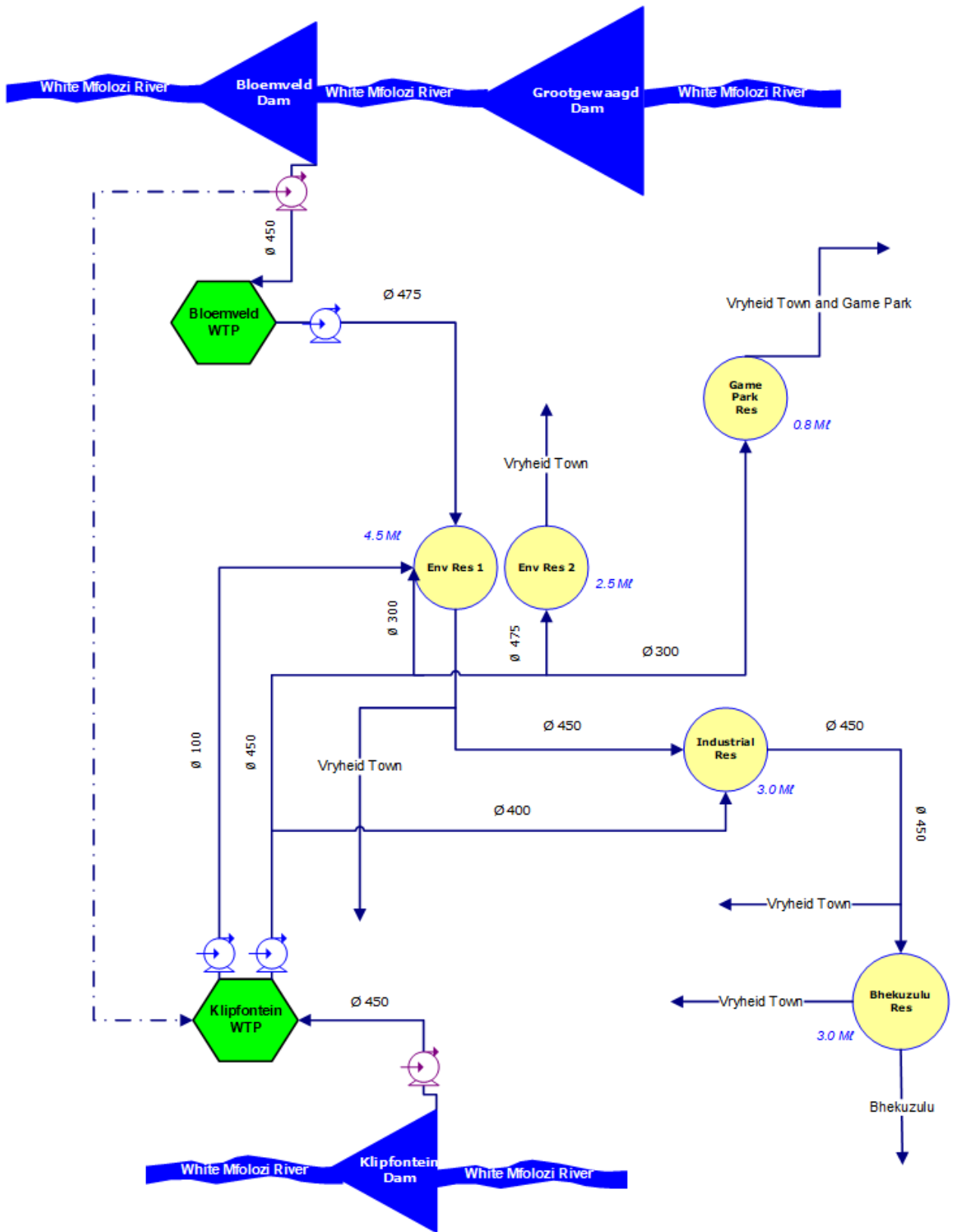

Figure 17.28 Schematic of the Vryheid Supply System

:

**Table 17.26 Pump details: Vryheid Supply System**

System	Pump Station Name	Number of Pumps		Pump Description	Supply From	Supply To	Static Head (m)	Duty Head (m)	Duty Capacity (Mℓ/day)
		Number of Duty Pumps	Number of Standby Pumps						
Vryheid	Bloemveld Raw water PS	3	1		Bloemveld Dam	Bloemveld WTP	4	8**	3
Vryheid	Klipfontein Raw Water PS	3	1		Klipfontein Dam	Klipfontein WTP	33	40**	5
Vryheid	Bloemveld PS	3	1		Bloemveld WTP	Environmental Res 1	15	25**	3
Vryheid	Klipfontein PS	3	1		Klipfontein WTP	Game Park Res	142	150**	1.5
Vryheid	Klipfontein PS	3	1		Klipfontein WTP	Environmental Res 2	104	115**	5

- \*\* These figures are based on calculated head loss

**Table 17.27 Reservoir details: Vryheid BWSS.**

System	Reservoir Site	Reservoir Name	Capacity (Mℓ)	Function	TWL (aMSL)	FL (aMSL)
Vryheid	Vryheid	Environmental Res 1	5.0	Balancing	1231*	1224*
Vryheid	Vryheid	Environmental Res 2	2.0	Distribution	1231*	1226*
Vryheid	Vryheid	Game Park Res	1.0	Terminal	1269*	1264*
Vryheid	Vryheid	Industrial Res	3.0	Terminal	1225*	1220*
Vryheid	Vryheid	Bhekuzulu Res	3.0	Terminal	1190*	1185*

\*These figures are estimates and must be verified

**Table 17.28 Pipeline details: Vryheid BWSS.**

System	Pipeline Name	From	To	Length (km)	Nominal Diameter (mm)	Material	Capacity (ML/day)	Age (years)
Vryheid	Raw water pipeline	Bloemveld Dam	Bloemveld WTP	0.8	450	Steel	20.6**	42
Vryheid	Raw water pipeline	Bloemveld WTP	Environmental Res 1	8.32	475	AC	20.6**	42
Vryheid	Potable water pipeline	Env Res 1	Industrial Res	2.175	450	AC	27.5*	42
Vryheid	Potable water pipeline	Industrial Res	Bhekuzulu Res	2.0571	450	AC	27.5*	42
Vryheid	Raw water pipeline	Klipfontein Dam	Klipfontein WTP	3.494	450	AC	20.6**	42
Vryheid	Potable water pipeline	Klipfontein WTP	Environmental Res 2	5.284	450	AC	20.6**	42
Vryheid	Potable water pipeline	Klipfontein WTP	Environmental Res 1	5.284	100	AC	1.01**	42
Vryheid	Potable water pipeline	Klipfontein WTP	Industrial Res	6.273	400	AC	16.3**	42
Vryheid	Potable water pipeline	Klipfontein WTP	Game Park Res	6.687	450/300	AC	9.16**	42

Based on a velocity of 2 m/s      \*\* Based on a velocity of 1.5 m/s    # Age need to be verified

The eMondlo WTP (**Figure 17.29, Table 17.29**) is positioned on high ground on the west of eMondlo Town in the Zululand District of Kwazulu-Natal.

The eMondlo WTP with an upgraded capacity of 12.0 Mℓ/day, receives raw water from the Mvunyana Dam as well as an abstraction from the Mvunyana River, 12km directly south of the plant on the Mvunyane River, a tributary of the White Mfolozi River. Four High lift pumps (**Table 17.30**) located at the eMondlo Raw Water Pump Station pump the raw water to the plant. The raw water is metered at the inlet to the plant and from there it is discharged into a storage pond at the inlet. The current demand on the eMondlo WTP is 16.0 Mℓ/day and there is no prospect of upgrading the existing plant

After treatment, potable water is gravity fed through a series of pipelines (**Table 17.32**) and reservoirs (**Table 17.31**) to the areas of eMondlo and Bhukemthethwo (**Figure 17.30**).



**Figure 17.29** An Aerial view of the Mondlo WTP (Google Earth 2020: website).

**Table 17.29 Characteristics of the eMondlo WTP.**

<b>WTP Name:</b>	eMondlo WTP
<b>System:</b>	Mfolozi Supply System
<b>Maximum Design Capacity:</b>	12.0 Mℓ/day
<b>Current Utilisation:</b>	16.0 Mℓ/day
<b>Raw Water Storage Capacity:</b>	0 Mℓ
<b>Raw Water Supply Capacity:</b>	12.0 Mℓ/day
<b>Pre-Oxidation Type:</b>	None
<b>Primary Water Pre-Treatment Chemical:</b>	Polymeric Coagulant
<b>Total Coagulant Dosing Capacity:</b>	13 ℓ/hour
<b>Rapid Mixing Method:</b>	Conventional Paddle Flash Mixer
<b>Clarifier Type:</b>	Dortmund Manual Clarifiers
<b>Number of Clarifiers:</b>	3 (2 rectangular and one circular)
<b>Total Area of all Clarifiers:</b>	485.14 m <sup>2</sup>
<b>Total Capacity of Clarifiers:</b>	12.0 Mℓ/day
<b>Filter Type:</b>	Gravity Sand Filters
<b>Number of Filters:</b>	6 (2 Pressure filters and 4 Gravity Sand Filters)
<b>Filter Floor Type</b>	Laterals with Nozzles
<b>Total Filtration Area of all Filters</b>	106.15 m <sup>2</sup>
<b>Total Filtration Design Capacity of all Filters:</b>	12.0 Mℓ/day
<b>Total Capacity of Backwash Water Tanks:</b>	0m <sup>3</sup>
<b>Total Capacity of Sludge Treatment Plant:</b>	None
<b>Capacity of Used Washwater System:</b>	0 Mℓ/day
<b>Primary Post Disinfection Type:</b>	Chlorine gas
<b>Disinfection Dosing Capacity:</b>	10 kg/hr Chlorinator
<b>Disinfectant Storage Capacity:</b>	
<b>Total Treated Water Storage Capacity:</b>	15 Mℓ

Figure 17.30 shows a schematic of the eMondlo Supply Network.



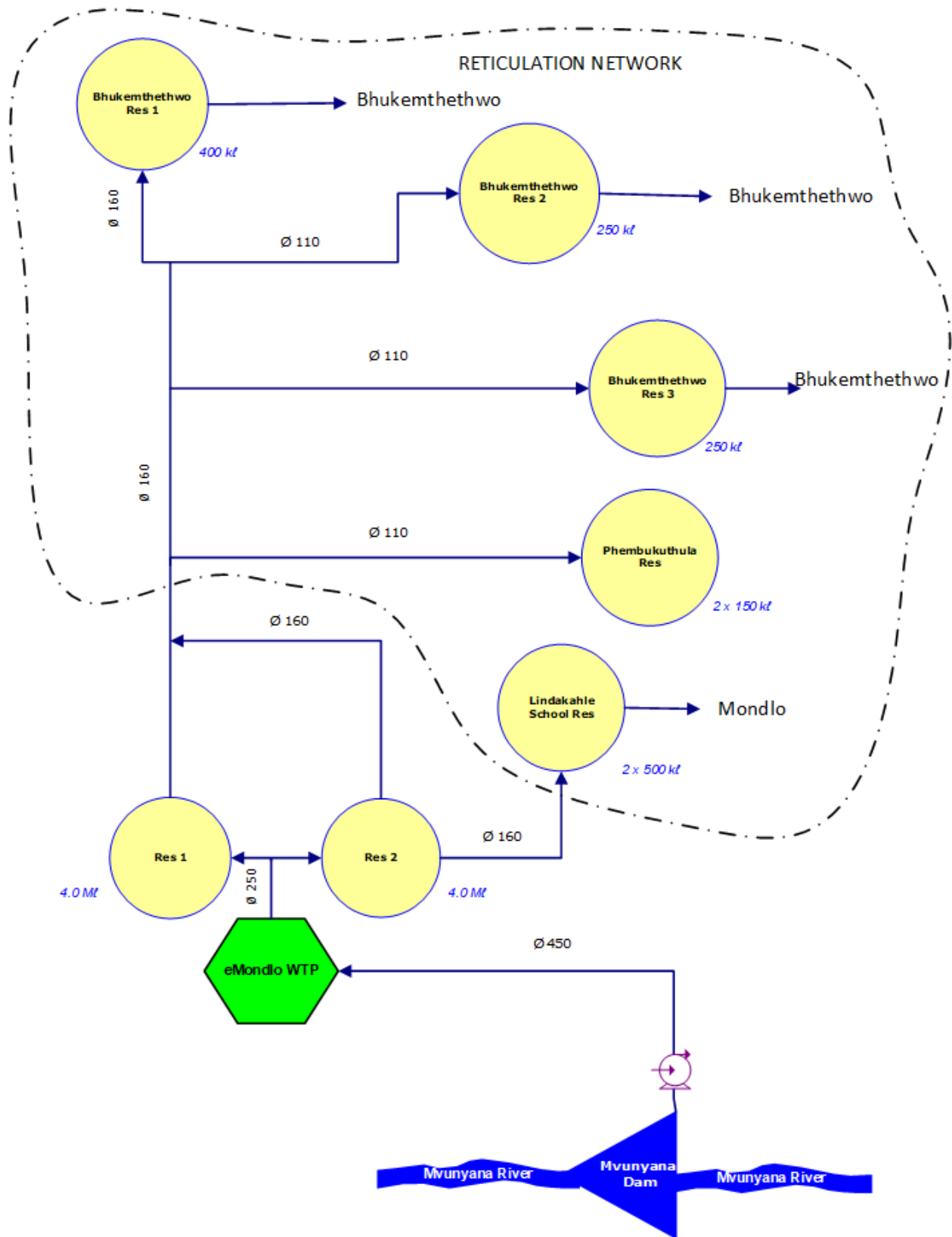

Figure 17.30 Schematic of the eMondlo Supply System

**Table 17.30 Pump details: eMondlo Supply System**

System	Pump Station Name	Number of Pumps		Pump Description	Supply From	Supply To	Static Head (m)	Duty Head (m)	Duty Capacity (Mℓ/day)
		Number of Duty Pumps	Number of Standby Pumps						
eMondlo	eMondlo Raw water PS	3	1		Mvunyana Dam	Mondlo WTP	180	236.1**	4

- \*\* These figures are based on calculated head loss

**Table 17.31 Reservoir details: eMondlo BWSS.**

System	Reservoir Site	Reservoir Name	Capacity (Mℓ)	Function	TWL (aMSL)	FL (aMSL)
eMondlo	eMondlo	Res 1	4.0	Distribution	1250.5*	1245*
eMondlo	eMondlo	Res 2	4.0	Distribution	1250.5*	1245*

\*These figures are estimates and must be verified

**Table 17.32 Pipeline details: eMondlo BWSS.**

System	Pipeline Name	From	To	Length (km)	Nominal Diameter (mm)	Material	Capacity (Mℓ/day)	Age (years)
eMondlo	Raw water pipeline	Mvunyana Dam	eMondlo WTP	12.0	450	Steell	20.6**	42
eMondlo	Raw water pipeline	eMondlo WTP	Res 1 and 2	0.087	250	AC	8.48*	42
eMondlo	Potable water pipeline	Res 1	Bhukemthethwo Res 1	3.662	160	uPVC	3.47*	42
eMondlo	Potable water pipeline	Res 1	Bhukemthethwo Res 2	4.440	110	uPVC	1.64*	42
eMondlo	Potable water pipeline	Res 2	Lindakahle School Res	2.011	160	HDPE	3.47*	42
eMondlo	Potable water pipeline	Res 1	Phembukuthula Res	2.820	110	uPVC	1.64*	42

Based on a velocity of 2 m/s

\*\* Based on a velocity of 1.5 m/s # Age need to be verified

## 17.3.2 Status Quo and Limitations of the Mfolozi System

### (a) Nkonjeni Regional Bulk Water Supply Scheme

#### Ulundi/Nkonjeni and Mpungamhlope Water Supply Systems

The Nkonjeni RBWSS has a well-developed and sustainable water source.

The existing design capacity of the Ulundi WTP is adequate to supply the projected demand until 2030. However, if the service area is increased then the plant will have to be upgraded and extended

The quality of the raw water upstream of the Klipfontein Dam is poor as a result of both wastewater return flows and from land use activities including commercial forestry.

The Klipfontein Dam situated near Vryheid was built to supply the conjunctive use of domestic water supply to Vryheid and Ulundi, and for irrigation water for the farmers downstream of the dam including the Gluckstadt Irrigation Scheme. Mpungamhlope which is located between the dam and Ulundi also benefits from the available water supply of the dam.

In 2018, the total raw water abstraction for treatment at the Mpungamhlope WTP, as well as for Makhosini, including the groundwater used to supplement the scheme, was estimated to be 0.69 million m<sup>3</sup>/annum (1.9 Mℓ/day) with a treated water production estimated to be 0.61 million m<sup>3</sup>/annum (1.67 Mℓ/day).

The estimated raw water losses in the raw water abstraction works and pipeline, as well as in the treatment processes, are estimated to be as high as 12% of the total raw water abstraction.

The current storage capacity of the system is 27 Mℓ and provides for a 36-hour storage based on current treated water production. In the summer months, this reduces to a 24-hour storage capacity, based on higher demand during that period.

The Ulundi WTP has been earmarked as the primary supply point for one of the planned 10 Regional Bulk Water Supply Schemes.

The projected demand for 2050 of the overall Nkonjeni RBWSS is estimated at 41.88 Mℓ/day

### (b) Usuthu Regional Bulk Water Supply Scheme (RBWSS)

#### Usuthu, Vuna/Embile and Ceza Supply System

The current raw water abstraction infrastructure cannot meet the current and future demand, as the Vuna WTP supply scheme is extended to supply the areas that have been serviced by boreholes and areas that have not previously been serviced. The current demand for potable water for the supply area is 6.39 Mℓ/day, whilst the capacity of the plant is 4.5 Mℓ/day.

There is a plan to consolidate this system with the Usuthu BWSS as one of the 10 Regional Bulk Water Supply Schemes with the primary point being the Usuthu WTP.

The average annual capacity of the water treatment works is insufficient to meet the immediate water requirements of the scheme given the high system losses. Currently, the scheme is supplemented with groundwater to meet the deficits in the requirements in some communities. There is a high silt load

in the White Mfolozi River and increased maintenance will have to be implemented to prevent the silting up of the abstraction works.

The Usuthu WTP currently comprise of two 2 Mℓ/day package plants and these are inadequate to meet the current demand. Zululand DM is in the process of constructing a 12 Mℓ/day conventional plant to meet the future projected demand. The Usuthu WTP will be one of the 10 Regional Bulk Water Supply Systems in this area and will be supplemented by the Vuna and Ceza BWSS.

The current abstraction infrastructure is inadequate to meet the demand and it is proposed that a feasibility study be undertaken to assess the viability of constructing a dam on the Black Mfolozi River.

## **(c) Hlahlindlela Regional Bulk Water Supply System (RBWSS)**

### **Vryheid Supply System**

The main function of Klipfontein Dam is to supplement the water supplies of Bloemveld and Grootegewaagd Dams (previously the main sources of raw water). Over the years, Vryheid's dependence on Klipfontein Dam has increased as demands have increased. There are no major water quality concerns at either the Bloemveld WTP or the Klipfontein WTP. The town of Vryheid, Bhekuzulu Township and the Vryheid WWTW are situated in the catchment area of the Klipfontein Dam. As a result, the water quality of the Klipfontein Dam could be impacted if effluent quality standards from the plant are not controlled. There is also a threat of uncollected litter and waste which could enter the dam through the stormwater system.

The capacity of the Vryheid WWTW is being upgraded so as to support the short and medium term demand. As the flows through the WWTW increase with time, the yield of the Klipfontein Dam will also increase.

Both WTPs are able to supply the required demand in the short to medium term and the resulting water quality is regarded as good. The Bloemveld plant has a neglected appearance but appears to be in adequate condition to continue operating, provided refurbishment is not unduly delayed.

The Vryheid BWSS has been consolidated with the eMondlo BWSS and some of the smaller schemes to form the Hlahlindlela Regional Water Supply Scheme.

### **eMondlo Supply System**

The available raw water supplies are sufficient to meet the current raw water requirements. The quality of the resource upstream of the Mvunyana Dam is not of good quality because of the wastewater return flows from Emondlo as well as the land use activities.

The eMondlo WTP has been refurbished and upgraded to supply 12 Mℓ/day but the demand has grown to 16 Mℓ/day. The Vryheid BWSS currently supplements the supply to the Mondlo BWSS.

The treatment works will have to be upgraded to meet the future projected demand. Future capacity increases would require major extensions to the works with a new inlet works, new clarifiers, new filters, as well as further upgrading of the chemical dosage systems. The site is fairly restrictive in terms of space and it may be more prudent to build an additional works near the dam and to pump the treated water to command reservoirs.

The eMondlo BWSS has been consolidated with the Vryheid BWSS and some of the smaller schemes to form the Hlahlindlela Regional Water Supply Scheme.

## 17.4 Water Balance/Availability

The first order water balance of the Mfolozi catchment suggests that there is a system deficit. Part of the reason for this is the lack of storage in the system. Additional storage would improve the assurance of supply. According to the Zululand DM-WSDP, 2004 the deficit is also as a result of the provisions made for future implementation of the Reserve.

According to the Zululand DM WSDP, 2004 a deficit in the system results from a demand which is higher than the 98% assured yield of the system (**Table 17.33**). This deficit is also as a result of provisions made for the future implementation of the Reserve.

**Table 17.33 Water balance - Water availability in the Mfolozi System for year 2000 (Zululand DM WSDP, 2004).**

		White Mfolozi	Black Mfolozi
		(million m <sup>3</sup> /annum) 98% assurance	(million m <sup>3</sup> /annum) 98% assurance
Available Water	Yield from Major Dams	15	0
	Yield from Minor Dams	7	2.3
	Run-of-River Yield	12.5	13
	Return flow	4.7	1.2
	<b>Total available</b>	<b>39.2</b>	<b>16.5</b>
Requirements	Irrigation	5	11
	Urban & Rural	19	5
	Mining & Industry	0	1
	Ecological Requirements	34	30
	<b>Total Used</b>	<b>58</b>	<b>47</b>
<b>Balance</b>		<b>-18.8</b>	<b>-30.5</b>

The following management and development options should be addressed in the White Mfolozi System:

- Providing additional water from the local surface water supplies of the White Mfolozi River, possibly including the raising of Klipfontein Dam.
- Review the proposal to construct an off-channel storage dam on the KwaNkweme River with a run-of-river scheme on the upper Black Mfolozi River.
- Implementation of Water Conservation and Demand Management measures, as a result of high system losses in the White Mfolozi River water supply systems.
- Pressure and Leakage management for Vryheid, Ulundi and Emondlo BWSS, the high average operating pressures may be contributing this leakage.
- Retrofitting and consumer metering implementation will improve the revenue sufficiency of the Zululand DM and the local municipality by selling an additional 1.85 million m<sup>3</sup>/annum, while retrofitting will reduce the consumer use by approximately 1.85 million m<sup>3</sup>/annum (DWS, 2014).



- Improving the operating practices between Klipfontein Dam and Ulundi weir (losses of around 17%) is critical. Changes to the current release patterns from Klipfontein Dam by synchronising with the Ulundi weir capacity and the abstraction for Ulundi can reduce the river losses. The scheduling of releases from Klipfontein Dam in order to reduce water losses in the system along the White Mfolozi River and at the Ulundi Weir is important. This should be supported by a system to monitor the movement of water and sediment.

## 17.5 Recommendations for the Mfolozi System

In January 2021, Umgeni Water concluded a Universal Access Plan, at a reconnaissance level, to assess the bulk and secondary bulk requirements for the Greater Zululand and uMkhanyakude District Municipalities. The study identified a number interventions to be implemented and are listed below:

### 17.5.1 System Components

According to the Zululand DM IDP 2012-2016, the geographic extent and nature of the district necessitates the consolidation of bulk water supplies across the district into 10 regional schemes, which further supply small stand-alone rural schemes. The regional bulk water supply schemes (RBWSS) are as follows:

- 1) Nkonjeni RBWSS (Mfolozi)
- 2) Usuthu RBWSS (Mfolozi)
- 3) Mandlakazi RBWSS (Pongola)
- 4) Gumbi/Candover RBWSS (Pongola)
- 5) Simdlangentsha East RBWSS (Pongola)
- 6) Simdlangentsha Central RBWSS (Pongola)
- 7) Simdlangentsha West RBWSS (Pongola)
- 8) Coronation RBWSS (Pongola)
- 9) Khambi RBWSS (Pongola)
- 10) Hlahlindlela RBWSS (Mfolozi)

Accordingly, it is understood that the "smaller water schemes" form part of or are planned to be incorporated into the regional schemes as shown in **Table 17.34**.

**Table 17.34 Proposed Regional Water Schemes in the Zululand District Municipality**

Item No	Name of Regional Water Scheme	Current Water Supply Scheme based on coverage area	Local Municipality
1	Nkonjeni RBWSS	Ulundi/Nkonjeni Osinisingini Nkonjeni Hospital Mpungamhlophe Babanango Masokaneni	Ulundi
2	Usuthu RBWSS	Nongoma/Vuna Ceza Thlasizwe Hospital	Nongoma
3	Mandlakazi RBWSS	Mandlakazi Khangela Palace Sidinsi Kombusi	Nongoma
4	Gumbi/Candover RBWSS		
5	Simdlangentsha East RBWSS	Spekboom PongolaTown (Simdlangentsha)	Uphongola
6	Simdlangentsha Central RBWSS	Belgrade Khiphunyawo Msibi	Uphongola
7	Simdlangentsha West RBWSS	Frischgewaagd Edumbe Ophuzana Tholakele	Edumbe
8	Coronation RBWSS	Hlobane Louwsburg Coronation	Abaqulusi
9	Khambi RBWSS	Khambi Village Mountain View Enyathi	Abaqulusi
10	Hlahlindlela RBWSS	Klipfontein Bloemveld Mondlo Mvuzini Purim	Ulundi

It is recommended that a Detailed Feasibility Study be undertaken to assess the most practical application and infrastructure requirements for efficient and effective supply networks.

### **(a) Hlahlindlela Regional Bulk Water Supply Scheme**

Water demand has been projected up to the year 2050. It includes 112 communities with Vryheid and eMondlo being formal urban areas with the rest being rural settlements. The Hlanhlindlela RBWSS is expected to have a demand of 55 Mℓ/day in 2050.

The White Mfolozi is the main source of water for the Hlanhlindelela RBWSS. However, there are water use entitlements for irrigation agriculture downstream of the Klipfontein Dam. The total registered irrigation water use downstream of Klipfontein Dam is 10.04 million m<sup>3</sup>/annum at a lower assurance of supply compared to the domestic sector. It is known that the registered irrigation water is currently not being used by irrigation agriculture.

The total bulk potable water production for 2011 for the White Mfolozi River catchment was 47.5 Mℓ/day. This figure includes the water requirements for Vryheid, eMondlo, Babanango and Nkonjeni supply areas. Currently the Hlanhlindelela scheme is experiencing water shortages and is the reason for projects being put on hold.

The Klipfontein Dam is situated on the Mfolozi River and supplies Vryheid town. The Grootgewaagd and Bloemveld Dams are situated on the aMagoda River and supplies water to Vryheid town. The Mondlo Township's main source of water is the Mvunyana Dam as well as direct abstraction from the Mvunyana River. Water is also released from the Klipfontein Dam to supply the Nkonjeni Regional Scheme (Ulundi). A water resource study will be necessary to identify potential surface water and groundwater augmentation options.

The Klipfontein Dam Raising Pre-feasibility study, to increase the yield of the Klipfontein Dam, was completed by DWS in 2018. The study investigated a number of options but it was recommended that the current FSL of the dam (1090 masl) be raised by 3.0 m to 1093 masl. The raising of the dam will provide an assured supply of water to Vryheid and its surrounding areas. The scheme can also increase the assurance of supply to eMondlo WSS, the Mpungamhlope WSS, the Ulundi WSS and to irrigators between the dam and the Ulundi Balancing Weir.

### **(i) Bulk Conveyance**

- From the Bloemveld WTP a primary  $\varnothing$  315mm bulk pipeline would need to extend in a northerly direction ( $\pm$ 11km) to primary Command Reservoir (CR1);
- From CR 1, a secondary bulk pipeline ranging from  $\varnothing$  63mm to  $\varnothing$  110mm will extend further north towards Obivane 2 community. Tertiary pipelines (approximately 11km in total) will branch off the secondary pipeline towards the communities of Obivane 2, Bivanyana, Penvaan and Khambula Mission. The tertiary pipelines will range between  $\varnothing$  50mm and  $\varnothing$  75mm;
- From CR 1 another secondary bulk pipeline needs to extend (approximately 49km) south east ranging between  $\varnothing$  63mm and  $\varnothing$  250mm. Tertiary pipelines will branch off towards the communities of Helberg Farms, Zunweni, Voorkeur, Bozuzu, Ntendeka 2, Shoba 1 & 2, Kwabanga 2, Golden Valley and Tint as Drift. The tertiary pipelines will range between  $\varnothing$  50mm and  $\varnothing$  125mm and amount to  $\pm$ 33km; 5km from the primary, tertiary pipelines (ranging between  $\varnothing$  50mm and  $\varnothing$  110mm) will extend (23km) in a northerly direction to serve the communities of Zungwini, Mthashana, Mqwabe and KwaManzi;
- From Klipfontein WTP, a primary bulk pipeline needs to extend ( $\pm$ 6km) to a second command reservoir at KwaMshomoloza; From CR2, secondary pipelines need to extend to the west and will range between  $\varnothing$  63 and  $\varnothing$  160mm for approximately 16km from where tertiary pipelines will branch off towards the communities of Driefontein, Fairplay, Mdlenevini, Fearmdale, Scheepersneck, KwaLubeck, Betel, Stillwater, Zaaifontein, Middelpunt and Geluk 3. The tertiary pipelines will range between  $\varnothing$  50mm and  $\varnothing$  63mm and total approximately 35km; The primary bulk pipeline will extend further south from CR2 to another command reservoir;

- Existing secondary pipelines extends from eMondlo WTP and feed Emondlo town, Phumbuthula, Enhlahelni, Zwelisha and Purim. Secondary pipelines range between  $\varnothing$  63mm and  $\varnothing$  315mm and amount to  $\pm$ 50km;
- From Mvuzini WTP an existing secondary pipeline extends to Nceceni from where an additional secondary pipeline (14km) is required to serve Emadwaleni, Mhlangeni, Mphezulu and hobozani. The secondary pipeline will range between  $\varnothing$  63mm and  $\varnothing$  160mm;
- From the existing secondary pipeline at the Purim WTW, additional secondary pipelines (ranging from  $\varnothing$  90mm to  $\varnothing$  200mm) will be required to extend (approximately 26km) further south to serve the Ezidulini, Nhloshana, Amahlathi, Ezibomvu 4, Esigodini, Qweqwe 1, Elosi and Sofaya communities; and
- From the CR3, future primary bulk pipeline, additional secondary pipelines ( $\varnothing$  63mm to  $\varnothing$  160mm) will extend eastwards (16km) from where it will extend further towards the south (19km) upto Gwebu CPA community. The secondary pipelines will range from  $\varnothing$  90mm to  $\varnothing$  140mm. Tertiary bulk pipelines ranging from  $\varnothing$  50mm to  $\varnothing$  90mm, will branch off (34km) to serve Nsengeni, Mawelawela, Langverwacht, Vamba, Brakfontein, Emooi, Enyanyeni, Brakpan, and Gwebu CPA communities.

### (ii) Storage

- The existing storage reservoirs need to be upgraded. The current storage capacity totals approximately 10M $\ell$  and needs to be upgraded to 17M $\ell$ ;
- Four (4) primary command reservoirs are required with capacities to vary between 2.2M $\ell$  and 5M $\ell$ ; and
- Eight (8) secondary reservoirs with capacities between 30k $\ell$  and 2M $\ell$  and 48 tertiary reservoirs with capacities between 30k $\ell$  and 1.6M $\ell$  will be required.

The storage capacity would need to be increased with an additional 35.2M $\ell$  to meet the 2050 water demand and to connect it to the Regional Scheme.

### (iii) Pump Stations

- Install a new pump station at Bloevmveld WTP (202kW).

## (b) Nkonjeni Regional Bulk Water Supply Scheme

The water demand for the Nkonjeni RBWSS was determined up to the year 2050. It includes approximately 175 communities with no formal urban towns. The rural communities are sparsely scattered and vast distances apart. Nkonjeni Scheme is expected to have a demand of nearly 42M $\ell$  in 2050.

At present the White Mfolozi catchment, at a 1:50 year level of assurance, is estimated at 51 million m<sup>3</sup>/a. The total current requirement is in the order of 98 million m<sup>3</sup>/a. The catchment is therefore severely stressed from a resource point of view. The Klipfontein Dam is the most significant water

resource and is situated in the upper reaches of the White Mfolozi River. The Klipfontein Dam can be used to increase the supply to Ulundi. The challenge in the White Mfolozi catchment is not that there is not enough water but there is a lack of dams which results in low firm yields and water shortages that occur during drought periods. A water resource study will be necessary to identify potential surface water augmentation options and possible dam developments.

The Ulundi and Babanango WTPs need to be upgraded to 32Mℓ/day and 0.5Mℓ/day, respectively.

### (i) Bulk Conveyance

- Clear water is pumped from the UlundiWTP via an existing  $\varnothing$  500mm rising main to a command reservoir. The WTP needs to be upgraded to 32Mℓ/day and the rising main to  $\varnothing$  813mm; From the command reservoir (CR1), an existing secondary pipeline extends (5.5km) to the Mkhazane community in Supply Zone 014 and needs to be upgraded to  $\varnothing$  400mm from where an existing  $\varnothing$  600mm and  $\varnothing$  350mm pipeline extends further to Matheng. From Mkhazane an additional  $\varnothing$  315 mm secondary pipeline will be needed running ( $\pm$ 28km) to the east through Supply Zone 014 towards Supply Zone 087 and into Supply Zone 086 to Zilulwane community. From Zilulwane an existing  $\varnothing$  125mm secondary bulk pipeline extends (10.5km) further north east to Onteku. Existing tertiary pipelines (ranging between  $\varnothing$  75mm and  $\varnothing$  110mm) branch off to Mbangweni, Mgababa 2 and Bhekimbazo. An additional  $\varnothing$  110mm tertiary pipeline (approximately 4km) will be required to serve Njomelwane. At Mthonjaneni community, tertiary pipelines (ranging from  $\varnothing$  110mm to  $\varnothing$  160mm) are needed to branch off south towards Supply Zone 084 to feed the communities of KwaMvula, Gijima, Enguqe and Ekatini. The tertiary pipelines total approximately 8.5km. Additional  $\varnothing$  125mm &  $\varnothing$  315mm tertiary pipelines will be required to run ( $\pm$ 10km) in a north easterly direction into Supply Zone 083 to serve Sqobelo and Ntabankulu. A  $\varnothing$  140mm tertiary pipeline will be needed to serve Supply Zone 088 (1.3km);
- Another existing  $\varnothing$  355mm secondary pipeline from CR1 extends east towards Supply Zone 013 to serve Ulundi Unit B1. The secondary pipe ( $\varnothing$  315mm) extends further to Ntendeka, Ulundi Unit D, Esthenilezitombi and Vukuza (14.5km) and is joined by the existing primary pipeline extending from the Nkonjeni Hospital WTP and Masokaneni WTP;
- An existing  $\varnothing$  400mm secondary pipeline extends from CR1 north to Mbudle. 1.2km from the CR1 a  $\varnothing$  355mm existing secondary extends (5km) in a northerly direction into Supply Zone 010 to the Cisholo community. From Cisholo the pipeline ( $\varnothing$  315mm) further extends to Mbeka (3.55km) where it joins with an existing  $\varnothing$  250mm secondary pipeline. The existing  $\varnothing$  250mm secondary pipeline extends to the east and joins the existing primary pipeline ( $\varnothing$  50mm) that comes from the Nkonjeni Hospital WTP and Masokaneni WTP (6km). An existing  $\varnothing$  250mm extends (3km) from the primary and secondary pipeline join north east through Supply Zone 015 to Mahlabathini. From Mahlabathini an existing  $\varnothing$  140mm tertiary pipeline extends (1.3km) north into Supply Zone 008 to Vutela;
- From Mbeka, an existing  $\varnothing$  315mm secondary bulk pipeline extends ( $\pm$ 4km) in a north westernly direction to Qwane Vuka in Supply Zone 012. At Manaba community, an existing  $\varnothing$  75mm tertiary pipeline runs north to Osengathini in Supply Zone 007;
- From Qwane Vuka an existing  $\varnothing$  200mm secondary bulk pipeline extends (4km) in a northerly direction to Mahleza (Supply Zone 059) from where it extends further north to Supply Zone 005 to Mbotsheni (3.5km). Here an existing  $\varnothing$  75mm tertiary pipeline branch off to the left to Mashulu in Supply Zone 005. From Mbotsheni an the existing  $\varnothing$  160mm secondary pipeline runs still in a northerly direction to Cobe in Supply Zone 056 ( $\pm$ 5km). Two existing tertiary pipelines ranging between  $\varnothing$  75mm and  $\varnothing$  110mm branch off on either side of the secondary pipeline. One tertiary pipeline branch off to the left to Dlebe ( $\pm$ 1.7km) in Supply Zone 004 and



the other branch off to the right to Kwayaka in Supply Zone 054 and further to Ndumakude in Supply Zone 055 ( $\pm 7$ km);

- From Cobe, the existing  $\varnothing$  125mm secondary bulk pipeline extends even further north to Kwamshayazafe 3 (7.5km) in Supply Zone 058 and ends at Njoline community in Supply Zone 057. The  $\varnothing$  90mm secondary pipeline to Njoline is approximately 4km;
- Also from Qwane Vuka, another existing  $\varnothing$  200mm secondary bulk pipeline extends in a north westerly direction to Ohlelo (2km) in Supply Zon 009. From here the  $\varnothing$  140mm secondary pipeline extends further (9km) through Supply Zone 053 to Supply Zone 051. The  $\varnothing$  125mm existing secondary pipeline passes through Supply Zone 51 (Mbombo & Mbekuzeni communities) to Supply Zone 052. From Supply Zone 52 the  $\varnothing$  90mm pipeline extends to Kwankakazi (3km). An existing  $\varnothing$  63mm tertiary branches off at Kwankakazi to Tukelana 2 in Supply Zone 066 ( $\pm 4$ km). Two existing  $\varnothing$  50mm tertiary pipeplines branch off on either side of the secondary pipeline. One towards Undindi community (3km) north of the secondary pipeline and the other to the south of the secondary pipeline in Supply Zone 053 (2.5km); From MpungamhlopeWTP (0.8M $\ell$ /day) an existing  $\varnothing$  160mm primary bulk pipeline extends south towards an existing command reservoir (CR2). A  $\varnothing$  315 mm primary bulk pipeline is needed from CR2 to extend to the east to CR1 at Ulundi WTP ( $\pm 15$ km). An additional  $\varnothing$  250mm secondary bulk pipeline is also needed to extend south from CR2 to Goje (3km). From here the  $\varnothing$  200mm secondary pipeline will be required to extend further (3km) south to Emahlathini and further to Hlungulwane Supply Zone 002 (2km) A  $\varnothing$  75mm tertiary pipeline will extend from the secondary bulk pipeline further south through Supply Zone 002, 006 and into 050 at Kweyezulu. From Emahlathini another  $\varnothing$  160mm tertiary bulk pipeline is needed (10km) to serve Mehlomane, Mgababa 3, Hodlweni in Supply Zone 49 and it will end in Supply Zone 003;
- The existing Babanango WTP needs to be upgraded to 0.5M $\ell$ /day. An existing  $\varnothing$  110mm primary bulk pipeline from the WTP extends to an existing command reservoir (CR3).

Bulk distribution to supply the whole Regional Scheme would need to be increased by approximately 98km. An additional 15km primary bulk pipeline ( $\varnothing$  315mm), 40km secondary (ranging between  $\varnothing$  63mm and  $\varnothing$  315mm) and 44km tertiary bulk pipelines (ranging between  $\varnothing$  75mm and  $\varnothing$  315mm) would be necessary to supply the whole of the Nkonjeni RBWSS

## **(ii) Storage**

- The existing storage reservoirs need to be upgraded. The current storage capacity totals approximately 16M $\ell$  and needs to be upgraded to 79M $\ell$ ;
- The three (3) primary command reservoirs (CR1, CR2 & CR3) need to be upgraded to 19.27M $\ell$ , 2.35M $\ell$  and 920k $\ell$  respectively;
- 24 Existing secondary storage reservoirs need to be upgraded to 42M $\ell$  with six (8) additional secondary reservoirs required with capacities between 360k $\ell$  and 1.5M $\ell$ ; and
- 20 Existing tertiary reservoirs need to be upgraded to 14.5M $\ell$  with 10 additional tertiary reservoirs required with capacities between 330k $\ell$  and 2.4M $\ell$ .

The storage capacity would need to be increased with an additional 78M $\ell$  to meet the 2050 water demand and to connect it to the Regional Scheme.

## **(c) Usuthu Bulk Regional Water Supply Scheme**

The Usuthu Regional Scheme is the largest water supply scheme in the district and supplies almost the entire Nongoma LM and also represents the biggest portion of the total backlogs. The eastern part of the Nongoma LM is supplied from the Mandhlakazi RWSS.

The scheme required the development of a new water source from the Black Mfolozi River and expensive bulk infrastructure to be rolled out over vast distances to scattered rural communities.

The sustainability of the main water source of Nongoma town is under severe strain and no longer sustainable during drought periods. The installation of a bulk pipeline from the Black Mfolozi River to Nongoma is currently in progress to address this issue. The internal bulks for Nongoma town will also be upgraded to augment the existing water supply.

## 18. UMKHUZE / UPHONGOLO / LAKE SIBAYA SYSTEM

---

### 18.1 Synopsis

The uMkhuze (W31 and W32), uPhongolo and Lake Sibaya (or Lake Sibayi) (W70A) systems run through the northeast region of the KZN Province and mainly supply water to the Umkhanyakude DM, as well as parts of the Zululand DM. The catchment area of these river systems is predominately rural, with commercial forest plantations and agriculture being the main economic activities. The uPhongolo System is shown in **Figure 17.31** and the uMkhuze System in **Figure 17.32**.

#### 18.1.1 Water Resources

##### (a) Overview

###### (i) uMkhuze Water Resource Region

The uMkhuze River is located in northern KwaZulu-Natal and has its source near a small town of Hlobane which is located east of Vryheid. The river runs near uMkhuze Game Reserve which constitutes the north-western part of the iSimangaliso Wetland Park - a world heritage site. The uMkhuze River is one of the main rivers supplying water to UMkhanyakude District Municipality, others being the uPhongolo and uMfolozi Rivers. Water can be transferred from the Pongolapoort Dam to the uMkhuze River to augment supply to the Mkuze town as well as the Zululand District Municipality. The uMkhuze Catchment includes the drainage areas of both the uMkhuze (W31) and Hluhluwe (W32) Rivers. The catchment is 9 545 km<sup>2</sup>, and the rivers discharge to Lake St Lucia which then drains into the Indian Ocean (Mhlathuze Water, 2016: 39).

The uMkhuze River System flows within tertiary catchment W31. The catchment consists of predominately commercial cattle or game farming (the main economic activities), with a small area of Traditional Authority land located in the southeast. The major water users in this catchment are irrigation and commercial forestry. Irrigators abstract water from run-of-river flows or farm dams. Some of the small towns in the region include Mkuze, Hluhluwe and Nongoma. The only significant dam in the catchment is the Hluhluwe Dam, which was constructed primarily for irrigation purposes. Today, the dam also supplies water for domestic purposes to the town of Hluhluwe.

The catchment is critical for the environmental flow requirements of Lake St Lucia and other areas east of the Lebombo Mountains. Lake St Lucia is an ecologically sensitive area and a World Heritage Site (Mhlathuze Water, 2016: 39).

The Hluhluwe system can be supplied from the Umfolozi River and the water supply schemes that are either dependent on the Umfolozi and Hluhluwe River systems, or that could potentially be supplied from the two systems, include the following:

- Mtubatuba Water Supply Scheme – this scheme includes the towns of St Lucia and Mtubatuba (which is located along the N2 highway). This scheme is dependent on run-of-river abstraction from the Umfolozi River.
- Hluhluwe Town Water Supply – the town and neighbouring communities are located on the left bank of the Hluhluwe River and are supplied by an abstraction works on the left bank of the Hluhluwe Dam.

- Hluhluwe Rural Water Supply Scheme – this scheme covers the area to the north and north east of Hluhluwe town, comprising mainly rural communities and is dependent on the water resources of the Hluhluwe River.
- Mpukunyoni Water Supply Scheme – this scheme is located west of Mtubatuba and is supplied by the Nyalazi River, a seasonal river that flows through the area into the Lake St Lucia.

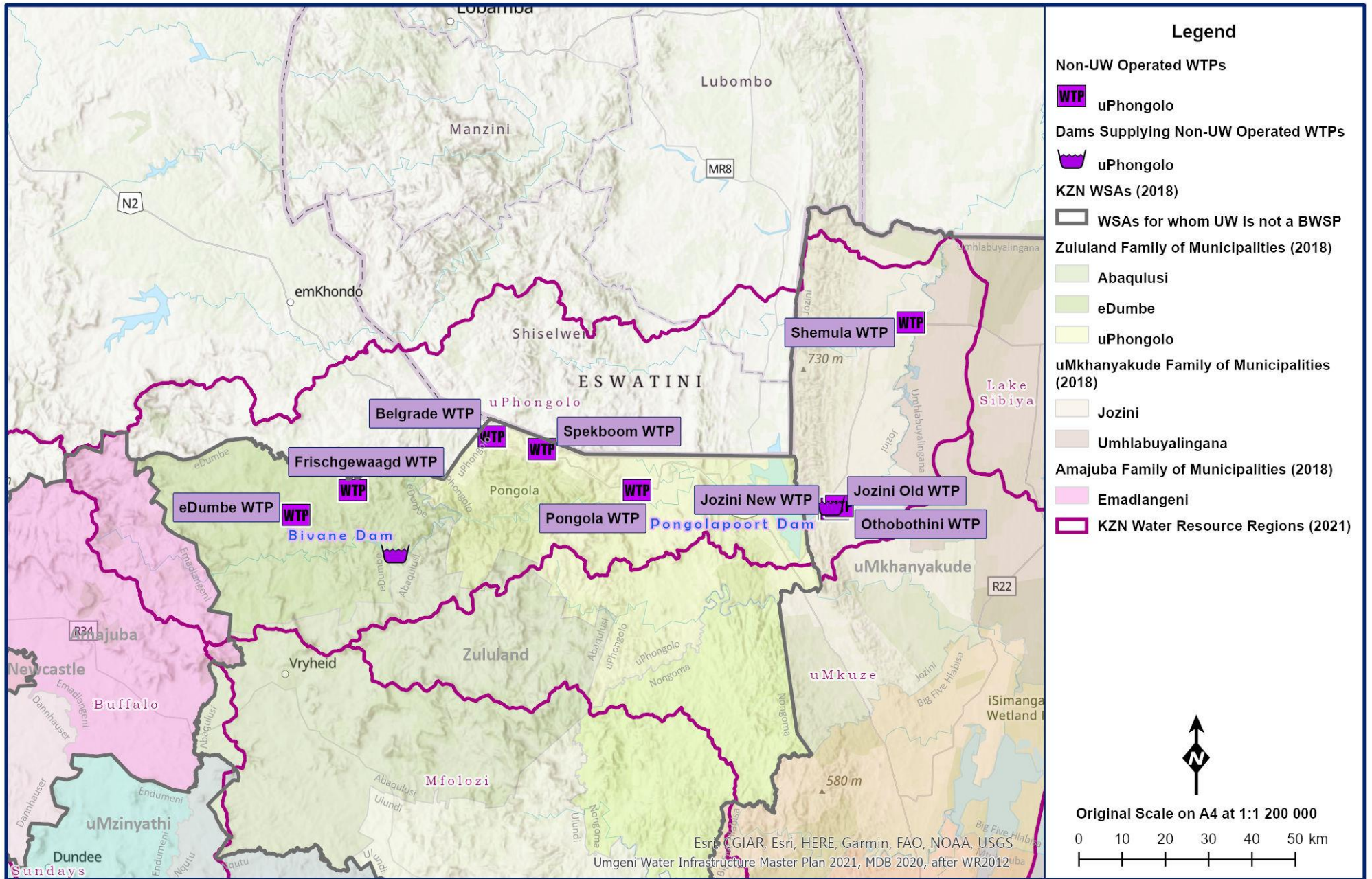

Figure 17.31 General layout of the uPhongolo System (MDB 2020, UW IMP 2021).



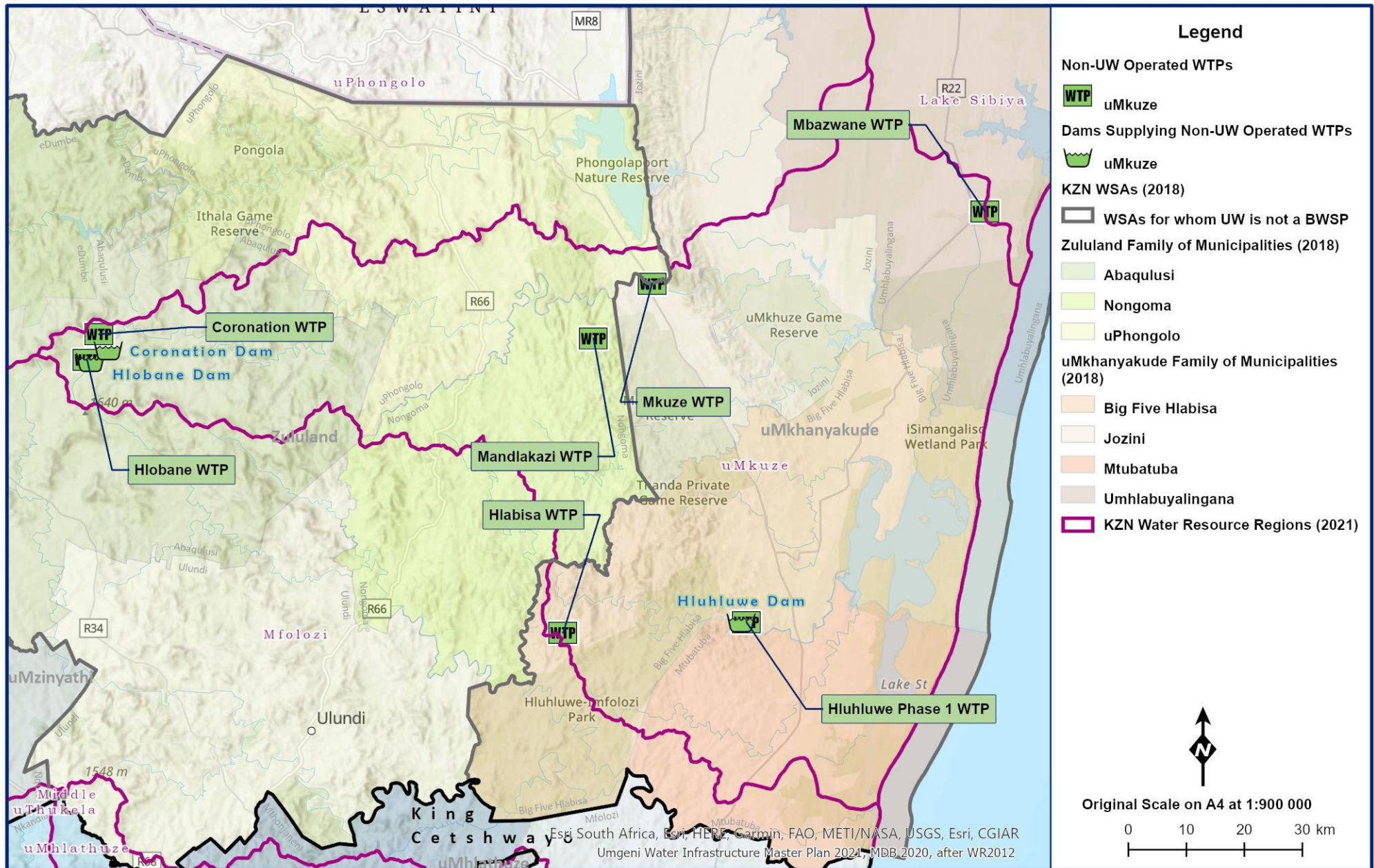

Figure 17.32 General layout of the uMkhuze System (MDB 2020, UW IMP 2021).

A general layout of the uMkhuze Region is shown in **Figure 17.33**. The dominant land cover in this region includes forestland (29%), cultivated (28%) and urban areas (17%).

## (ii) uPhongolo Water Resource Region

The uPhongolo River passes through the Lebombo Mountains along the Zululand-Umkhanyakude municipal boundary and flows into the Pongolapoort Dam (commonly referred to as Jozini Dam). The river sources its water along the eastern escarpment of the Mpumalanga-KwaZulu-Natal provincial boundary. The uPhongolo River flows from the Zululand District Municipality, with some of its catchments situated in Swaziland. It passes through the Umkhanyakude District Municipality into Mozambique, where it becomes the Maputo River (**Figure 17.34**).

The water resources of the uPhongolo River System have been developed for conjunctive use. This includes the direct abstraction from the Pongolapoort Dam, the releases from the dam for downstream abstraction by existing water supply systems, the groundwater abstraction, particularly in the W70A coastal aquifer and abstraction from Lake Sibaya.

According to Lankford, Pringle and Dickens (2011):

“Below Pongolapoort Dam the river meanders across a gently sloping floodplain with numerous pans which are dependent upon periodic flooding by the river. The floodplain extends for approximately 50 km in length, varying in width between 0.8 and 4.8 km to the confluence of the Pongola and Usutu Rivers, on the border with Mozambique. The area is located in a warm to hot, humid subtropical climatic region with most rainfall falling in the summer (December to March). Data from the Makhathini Agricultural Research Station, adjacent to the floodplain, show mean monthly temperatures of 16.6 °C in June and 26.8 °C in January”.

The uPhongolo System consists of the following main water supply schemes:

- Simdlangentsha West Water Supply Scheme – the supply mainly comes from uPhongolo River abstractions and the Bivane Dam.
- Simdlangentsha East Water Supply Scheme – the supply to the town of Pongola mainly comes from the uPhongolo River.
- Mandlakazi Regional Water Supply Scheme – the supply to the area of Mandlakazi, located on the eastern side of the town of Nongoma, comes from Pongolapoort Dam.

The uPhongolo catchments are characterised by large-scale afforestation in the upper uPhongolo and Bivane tributaries as well as large-scale irrigation in areas upstream of the Pongolapoort Dam. The main irrigated crop is sugarcane. Apart from the Pongolapoort and Bivane Dams, irrigators receive water through a system of canals constructed by the Department of Water and Sanitation (DWS) in the 1970s. This scheme is known as the Pongola Government Water Scheme and was upgraded in the early 1990s. The Bivane Dam also supplies the town of Pongola with water via irrigation canals in the lower uPhongolo Catchment. The Pongolapoort Dam is the main source of domestic water supply for the downstream water users up to the border with Mozambique. Water is also transferred from the Dam to the uMkhuze River where it supplies the Mkuze town as well as the Zululand DM.

The water supply schemes that are dependent on the Pongolapoort Dam, or could potentially be supplied from the system, include the following:

- Shemula Water Supply Scheme – this is the largest scheme which may be extended to include Phelindaba and KwaNgwanase in the future as continued groundwater abstraction may negatively

impact on the wetlands in these areas. The Shemula scheme is dependent on releases from the Pongolapoort Dam.

- Jozini north and Nondabuya Schemes – these schemes are located on the left bank of Pongolapoort Dam and are supplied by an abstraction works on the left bank of the dam.
- Jozini-Makhathini Water Supply Scheme – The town of Jozini is located on the right bank of Pongolapoort Dam and extends to the shores of the dam. It is supplied directly from the dam. The scheme extends into Makhathini Flats up to a small river called Muzi and the uMkhuze River in the south. Depending on the availability of the water resources of Lake Sibaya and groundwater, the scheme areas of Mbazwana and Mseleni may, in the long-term, be supplied from the uPhongolo River.
- uMkhuze-Ubombo Water Supply Scheme – This scheme is supplied from the uMkhuze River and supplemented by the uPhongolo River.

### (iii) Lake Sibaya Water Resource Region

Lake Sibaya (or Lake Sibayi or Lake Sibhayi) is the largest freshwater lake in South Africa and currently supplies the Mseleni and Mbazwana Water Supply Systems. The lake has an estimated inflow of approximately 25 million m<sup>3</sup>/annum (UW, 2020) and the lake has an estimated storage capacity of 700 million m<sup>3</sup>. Groundwater recharge is high, as is the groundwater potential. Although Lake Sibaya has an abundance of coastal resources, it is also susceptible to pollution and siltation due to human influences.

The Lake Sibaya catchment is groundwater-driven, with no major rivers flowing into the lake. Due to the sandy nature of the soils surrounding the lake, the amount of surface runoff is limited and consequently the water levels within the lake are maintained largely by groundwater inflow (Smithers et al., 2017). The only significant surface drainage feature for the Lake Sibaya catchment is the Mseleni Stream feeding the western arm of the lake (**Figure 17.35**).

The Lake Sibaya area of supply faces a physical water scarcity threat as the lake's water level has been constantly declining since the year 2000. This is a major concern among local stakeholders as the lake is the main source of water for the local town of Mbazwana and surrounding areas. From what was once a big, 70 km<sup>2</sup> freshwater body, Lake Sibayi has now been disjointed into different sections, with the southern arm being completely removed from the main lake. If the declining level trend continues, more segments are likely going to be separated from the main lake.

The main economic activity in the lake's catchment, commercial forestry (covering 115 km<sup>2</sup> of the catchment), has been suggested to be the major driver of the declining lake levels (Smithers et al., 2017). Due to their tall, dense and evergreen canopies (which maintain a relatively high leaf area index over the entire year), commercial forest plantations have been found to use more water than replaced natural grasslands. In addition, commercial forest plantations are characterized by deep rooting systems which have an ability to access groundwater reserves.

Another major cause of the declining water levels is the observed below-average precipitation received in the area since cyclone Eline in 2000 (Smithers et al., 2017). In contrast to the low precipitation levels, the population and hence the demand for domestic water supply has been gradually increasing. Abstraction for local domestic water supply has been estimated to be 1.35 million m<sup>3</sup>/annum and may increase in the medium term. The declining lake water level will impact on the lake's yield, thus increasing the risk of non-supply.

The lake's condition has attracted interest from various stakeholders. In particular, the South African Environmental Network (SAEON) has developed a network of hydro-meteorological monitoring equipment and stations to enhance the understanding of the relationship between local climate, land use and lake water levels. Variables being monitored include the lake's water level, groundwater levels in strategic points, water level in the Mseleni stream and climatic variables (e.g. rainfall, temperature, humidity, etc.) at various parts of the catchment.

SAEON's research also seeks to establish an understanding of water movement in the lake's catchment area, as well as the lake's interaction with the sea. Although the volumes are not fully understood, it is suspected that a relatively small amount may be lost from the lake through seepage to the sea.

The observed negative changes to Lake Sibayi's physical characteristics have prompted the local communities to investigate the potential to invest in alternative land use activities to yield higher economic returns with a lower water footprint, as opposed to commercial forest plantations (Shabalala et al., 2022). There is ongoing research to investigate the water use of macadamia nut trees as a potential replacement for commercial forest plantations in the area. Developments from this study will be reported when the results are available.



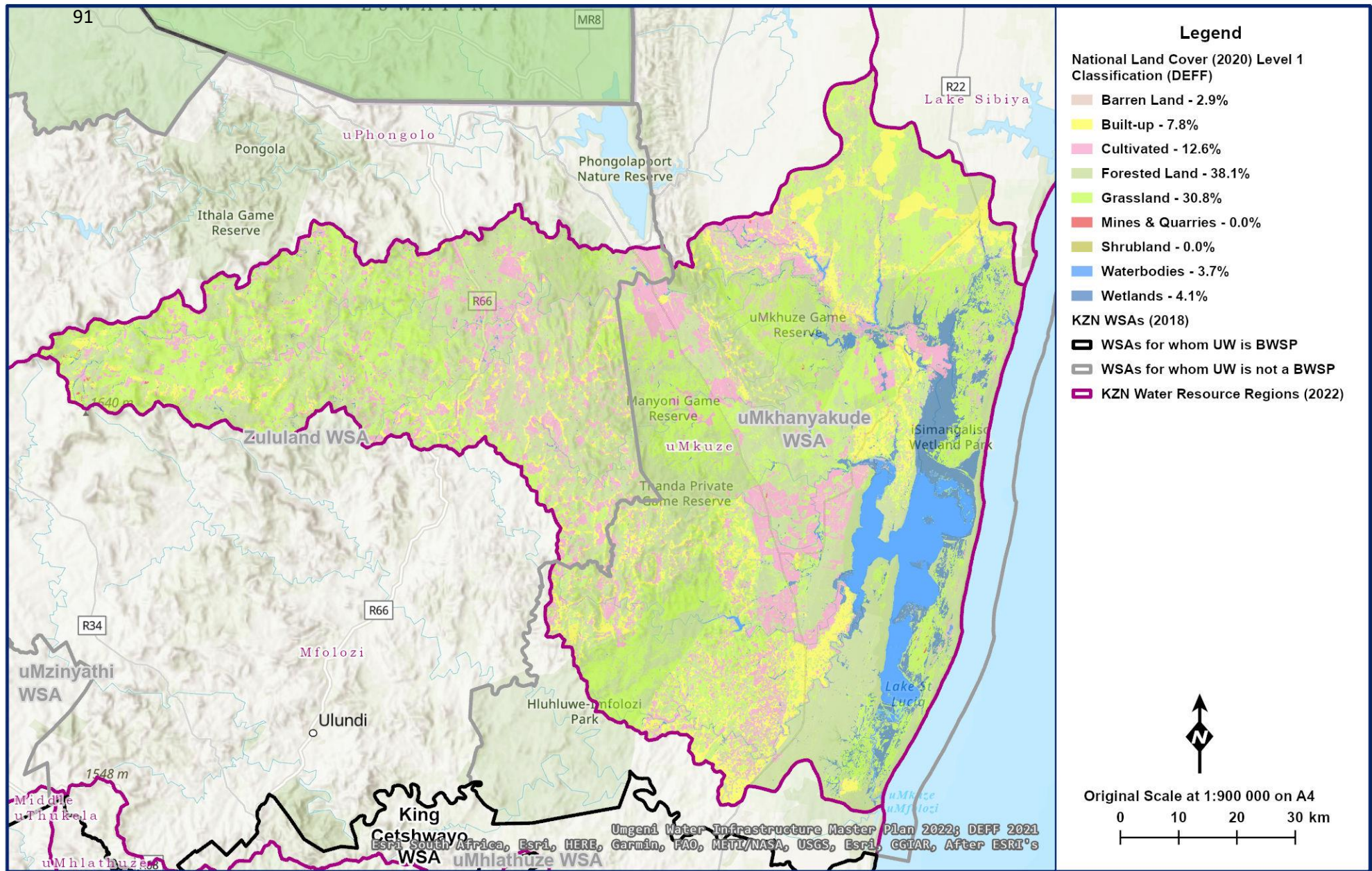

Figure 17.33 General Layout of the uMkhuze Region (DEFF 2020, MDB 2020, Umgeni Water 2022, WR2012).



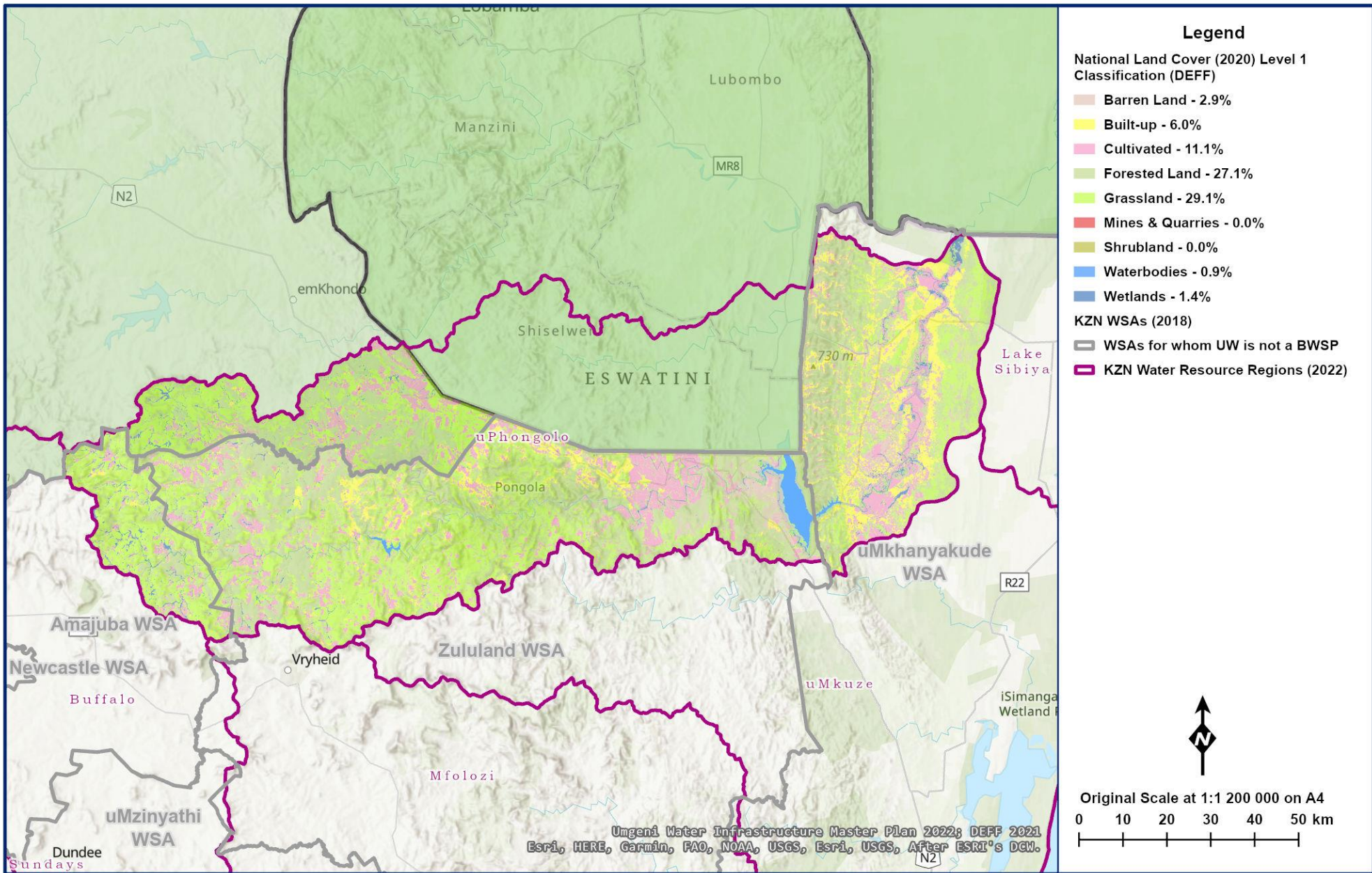

Figure 17.34 General Layout of the uPhongolo Region (DEFF 2020, MDB 2020, Umgeni Water 2022, WR2012).



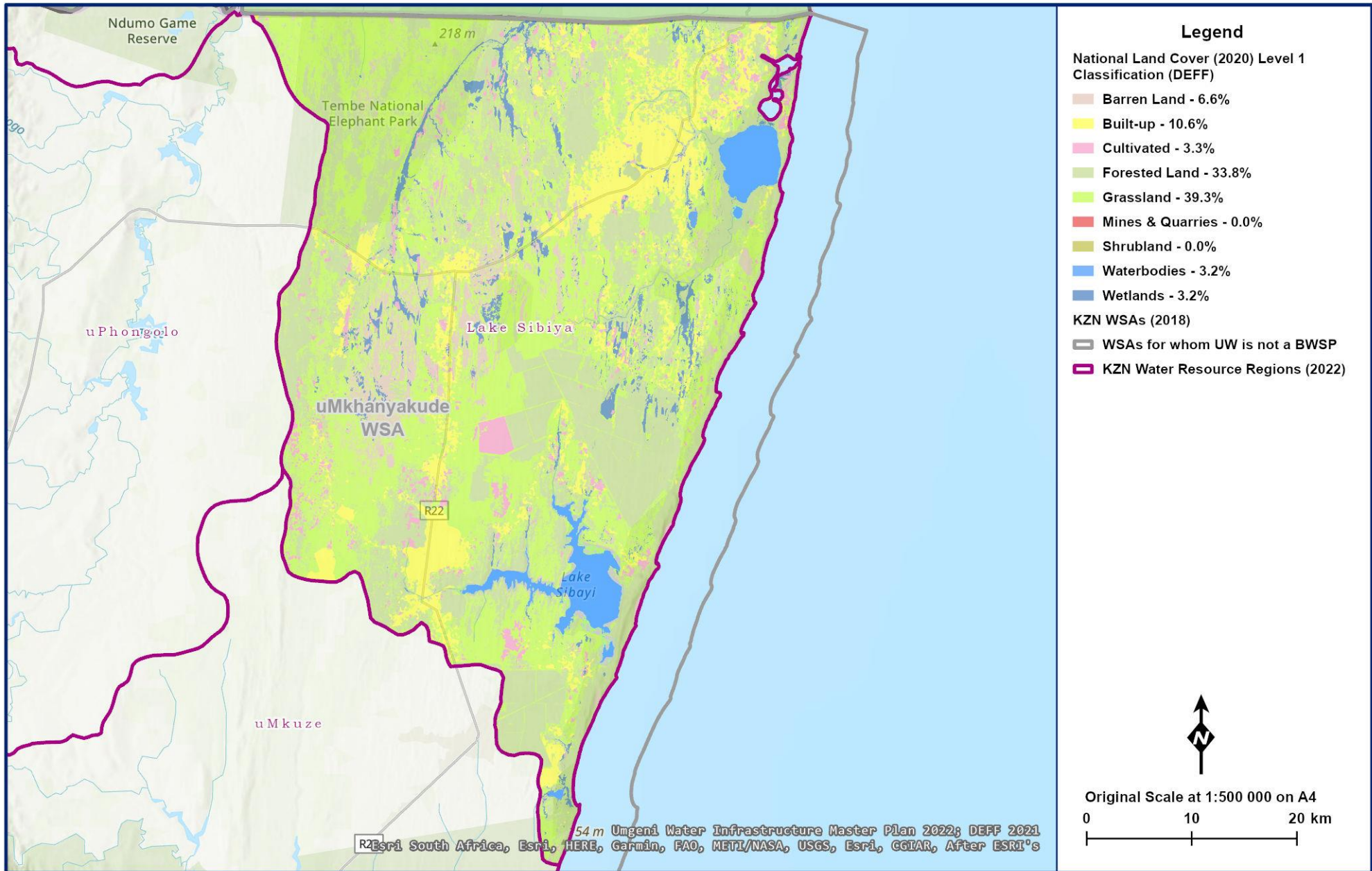

Figure 17.35 General layout of Lake Sibayi System (DEFF 2020, MDB 2020, Umgeni Water 2022, WR2012).

## (b) Surface Water

The hydrological characteristics for the uMkhuze, Uphongolo and Lake Sibayi Water Resource Regions are summarised in **Table 17.35**, **Table 17.36** and **Table 17.37**, respectively.

**Table 17.35 Hydrological characteristics of the uMkhuze Region (WR2012: Usutu-Mhlathuze Quat Info WMA 6 7Jul2015 spreadsheet)**

Region	River (Catchment)	Area (km <sup>2</sup> )	Annual Average			
			Evaporation (mm)	Rainfall (mm)	Natural Runoff (million m <sup>3</sup> /a)	Natural Runoff (mm)
uMkhuze	uMkhuze River (W31)	4630	1435	851	469.9	101.5
	uMkhuze River (W32)	4916	1491	778	291.3	59.3
	<b>Total</b>	<b>9546</b>				

**Table 17.36 Hydrological characteristics of uPhongolo Region (WR2012: Usutu-Mhlathuze Quat Info WMA 6 7Jul2015 spreadsheet)**

Region	River (Tertiary Catchments)	Area (km <sup>2</sup> )	Annual Average			
			Evaporation (mm)	Rainfall (mm)	Natural Runoff (million m <sup>3</sup> /a)	Natural Runoff (mm)
uPhongolo	W41	1691	1413	887	264.5	156.4
	W42	4088	1423	863	564.2	138.0
	W44	2003	1500	619	51.9	25.9
	W45	1798	1500	615	49.9	27.8

**Table 17.37 Lake Sibaya Hydrological Characteristics (WR2012: Usutu-Mhlathuze Quat Info WMA 6 7Jul2015 spreadsheet)**

Region	Lake Sibaya (Catchment)	Area (km <sup>2</sup> )	Annual Average	
			Evaporation (mm)	Rainfall (mm)
Lake Sibaya	Lake Sibaya (W70)	530	1500	769

According to the Zululand District Municipality Water Services Development Plan (2004):

“The total surface water resources of the uPhongolo catchments are estimated at about 910 million m<sup>3</sup>/annum, and return flows are estimated to be about 10% of the irrigation demand, or 20 million m<sup>3</sup>/annum. The water resources of the uPhongolo catchments are fully developed through the Pongolapoort Dam. The dam is a 2.5 x MAR dam which produces a large yield from the substantial runoff of the uPhongolo catchments and there is no further scope for increasing the yield as a whole. However, surplus yield is available although there are uncertainties regarding the magnitude due to uncertainties surrounding the environmental requirements. The Bivane Dam was constructed in the Bivane catchments to increase the assurance of supply to irrigators upstream of the Pongolapoort Dam. There is an existing operating rule that determines the frequency and magnitude of flood releases from the Pongolapoort Dam to meet social and environmental requirements on the flood plains

downstream of the dam. These releases reduce the yield of the Pongolapoort Dam substantially (by about 250 million m<sup>3</sup>/a). However, the downstream parties do not always welcome these releases and Mozambique has recently objected, as have riparian farmers along the lower uPhongolo River”.

## (c) Groundwater

### (i) Mkuze Region

The Mkuze Region is located in two hydrogeological regions, the North Zululand Coastal Plain and Southern Lebombo (DWAF, 2008) (**Figure 17.36**).

### Hydrogeological Units

The inland area, west of the coastal strip is dominated by the igneous and sedimentary rocks of the Karoo Supergroup. The Lebombo Group basalts and rhyolites make up the majority of the igneous lithology. The sedimentary shales, mudstones and sandstones can be found in the Beaufort and Ecca Groups.

In the coastal strip the Zululand Group is made up of mainly siltstones, conglomerates and sandstones and overlies the volcanic succession of the Lebombo Group. The Zululand Group underlies most of the coastal plain, but are exposed mainly along its inland westerly marginal areas along the Lebombo.

### Geohydrology

The coastal area is unique in that it essentially comprises an unconsolidated to semi-consolidated sedimentary sequence, with few “hard-rock” areas. Another aspect that is of importance is the interaction between the many natural inland lakes and the groundwater regime.

The basal conglomerate layer of the Zululand Group, the Makatini Formation, is the most promising horizon geohydrologically. The Mzinene and St Lucia Formations have a low permeability and water quality is generally extremely poor. These formations are overlain by the Uloa Formation. In terms of water bearing characteristics this is the best aquifer in the entire succession. The Uloa Formation is in turn overlain by the unconsolidated Aeolian sands of the Port Durnford Formation. The overlying sands of the Berea Formation cover large parts of the area.

Important geohydrological units inland include the sandstones of the Vryheid and Natal Group. Groundwater occurrence in the Vryheid Formation sandstone is generally associated with dolerite intrusions, fractures and faults. The difference in the formation of secondary porosities in the Natal Group and the Vryheid sandstone is the absence of dolerite intrusions affecting the former.

Very few lineaments of regional scale and no dykes are discernible in the area underlying the Natal Group sandstone.

### Groundwater Potential

The Zululand coastal plain has a huge groundwater development potential. The Port Durnford Formation acts as a huge storage reservoir for the Uloa aquifer, although it also is a good aquifer. Production boreholes developed in these formations are capable of producing yields of up to 15 ℓ/s provided the boreholes are well designed and developed.

The sands of the Berea Formation are frequently exploited for water by the local population. Hand dug wells of approximately one metre in diameter and generally less than 5 m in depth are common

throughout the area. These are usually equipped with handpumps or left open. If properly developed and with appropriate screens and gravel packs, these sands can yield up to 4 ℓ/s.

The flat coastal plain and shallow groundwater table, results in a close relationship between the surface water bodies (inland lakes) and the groundwater. The Zululand coastal plain is a largely unexploited aquifer system, however, it is delicately balanced and the environmental consequences should be examined before exploitation is considered.

### Water Quality

The chloride content, as a percentage of the total dissolved solids is generally high in the study area. However, it is effectively washed away in sections where the effective Mean Annual rainfall (MAR) is high. In the western areas of the study area, surrounding Hlabisa, where the MAR is in excess of 1000 mm/annum, the chloride content in borehole water is lowest. The relatively high chloride content in geological Groups and Formations particularly in the Dwyka (Tillite) Formation, the Eccca Group and the Letaba Formation basalt, is due to salt being carried inland by the prevailing winds from the Indian ocean as far as the escarpment.

The magnesium concentrations in the Letaba Formation are the product of dissolution of mafic minerals such as olivine, are relatively high averaging 65 mg/ℓ.

Groundwater from Vryheid sandstone is characterised by a wide range in electrical conductivity. This can be associated with the situation that some of the boreholes were drilled into the contact zone between the dolerite and the surrounding sandstone, others in unaltered host sandstone.

The overall quality of groundwater in the coastal plain is good, with pH generally ranging between 6 and 9 and electrical conductivity (EC) generally < 100 mSm. There appears to be a correlation between the geology and the EC. Low EC (< 50 mSm) appear to be concentrated in the eastern parts of the coastal plain, whereas the higher EC ground waters tend to be associated with the older geological formations (Uloa and Lebombo).



## **(ii) Phongola Region**

The Phongola Region is located in four hydrogeological regions, the Northern Zululand Coastal Plain, Southern Lebombo, Northeastern Middleveld and. Northwestern Middleveld.

### **Hydrogeological Units**

The catchment is distinctive from others in the province due to the dominance of the Pongola Supergroup for almost the entire area. These metamorphosed sedimentary rocks and volcanic rocks rest unconformably upon the granites. There are several major structural trends in these rocks, indicative of a complex structural history; the strata are folded and extensively fractured and faulted.

Rocks of the Karoo Supergroup comprising the Dwyka, Pietermaritzburg and Vryheid Formations are found surrounding Jozini Dam. The Dwyka formation lies unconformably on the underlying Basement Granite, Pongola and Natal Group rocks.

Dolerites are unusual in the Pongola rocks where older diabase dykes are prominent.

### **Geohydrology**

The Pongola rocks can be weathered up to 30m deep and are placed in the weathered and fractured class. Weathering of the Tillite is limited and generally <20m, therefore the Dwyka Formation is classified as a fractured aquifer. The main control to exploitable groundwater occurrence in the Pietermaritzburg shales is the presence of fracturing associated with the dolerite intrusive. The aquifer is classified as fractured. Weathering of the Vryheid Formation sandstone is limited to less than 20m and groundwater is controlled by fracturing, jointing and contact zones with dolerite intrusives. The aquifer is assigned to the fractured class.

### **Groundwater Potential**

There are relatively few boreholes in the area of the Pongola rocks due to the rugged topography and reliance on springs and surface water. This area is well watered by rivers and streams. Borehole records for this area indicate that some very good yields have been achieved. These boreholes are in the Simlandgentsha District and have blow yields of 11 to 21 ℓ/s. These are however, exceptionally high yields. Typical yields are in the moderate range (0.5 to 3 ℓ/s). Reported water strikes range from 6m to 119m, with a median of 32m. This relatively shallow depth indicates that weathering plays an important role in the mode of groundwater occurrence in the Pongola rocks.

The Dwyka is generally a moderate aquifer with boreholes having yields of 0.5 to 3 ℓ/s. However, the Dwyka Tillite has the largest marginal class (<0.1 ℓ/s) when compared to the other hydrological units.

Borehole yields in the Pietermaritzburg shales are generally moderate. Due to the relatively narrow outcrops of the shale in many area, boreholes in which the Pietermaritzburg Shale is an aquifer often comprise other hydrological units e.g. Vryheid Formation. Yields in the Vryheid Formation are moderate having a yield of 0.5 to 3 ℓ/s. Dykes and sills are important for the occurrence of groundwater in these sandstones as for that in the Pietermaritzburg Shales.

## Water Quality

When analysing groundwater water quality consideration must be given to the fact that water strikes in secondary fractured aquifers occur along lithological breaks and possibly two dissimilar rock types, which can have an influence on the water chemistry. The groundwater is generally of good quality (<70 mSm). Groundwater of unacceptable quality is found in areas in the Dwyka Tillite and Pietermaritzburg Formation shales.

Nitrate levels are generally below the maximum guideline of 5 mg/ℓ as N. Areas with higher nitrate where prone to be situated too close to a source of organic waste e.g. pit latrines.

Fluoride values are also generally below the maximum guideline value of 1 mg/ℓ.

Ambient water quality is generally good, with Total Dissolved Solids (TDS) ranging from 300 mg/ℓ for boreholes in the Vryheid Formation to 900 mg/ℓ for the Natal Group.

## (iii) Lake Sibaya

The Lake Sibaya region is located in the Northern Zululand Coastal Plain hydrogeological region (DWS, 2008) (Figure 17.38).

### Hydrogeological Units

The area is essentially a flat sandy coastal plain. Geologically the area is covered by mainly unconsolidated to semi-consolidated fine sands overlying rocks of Tertiary and Cretaceous age. No structural geological features that influence groundwater conditions have been identified in the area.

The rocks of Tertiary and Cretaceous age can be regarded as floor rocks. The Zululand Group of mainly siltstones, conglomerates and sandstones overlies the volcanic succession of the Lebombo Group. This group consists of three stratigraphically conformable formations, the St Lucia, Mzinene and Makatini. These underlie most of the coastal plain, but are exposed mainly along its inland westerly marginal groundwater areas along the Lebombo.

The Lebombo Group is overlain by the Uloa Formation which is richly fossiliferous and one of the main aquifers in the succession.

The Uloa Formation is overlain by the Port Durnford formation, which is a thick succession of loosely consolidated sands, silts, clays and lignite.

The Port Durnford Formation is overlain by fluvial and Aeolian sands.

### Geohydrology

The area is covered by essentially unconsolidated to semi-consolidated fine sands containing varying amounts of clay and silt. This aquifer is therefore classified as intergranular in nature.

The Uloa Formation shows numerous karstic conditions and is therefore classified as "Karstic".

The Port Durnford has a large storage capacity and low permeability due to fine grain size and argillaceous character in places. The Port Durnford is classified as intergranular in nature.

### **Groundwater Potential**

In terms of groundwater potential the Makitini Formation is the most promising horizon. The sedimentary rocks of the Mzinene and St Lucia formations have low permeability and water quality is generally poor.

The Uloa Formation has good groundwater potential and numerous boreholes extracting in excess of 10 ℓ/s from the upper parts of this unit.

The Port Durnford has a large storage capacity and low permeability due to fine grain size and argillaceous character in places. Production boreholes developed in this formation are capable of producing yields of up to 15 ℓ/s

Because of the generally shallow water levels in the overlying sands covering large parts of the area, the local population frequently exploits these for water. Hand dug wells of approximately 5 m deep are common and are usually equipped with handpumps or left as open wells.

### **Water Quality**

Overall the water quality is good with almost 90% of all groundwater samples analysed have electrical conductivity of <100 mS/m.

The quality of groundwater in the Lebombo Group is extremely poor with TDS values typically >5000 mg/ℓ.

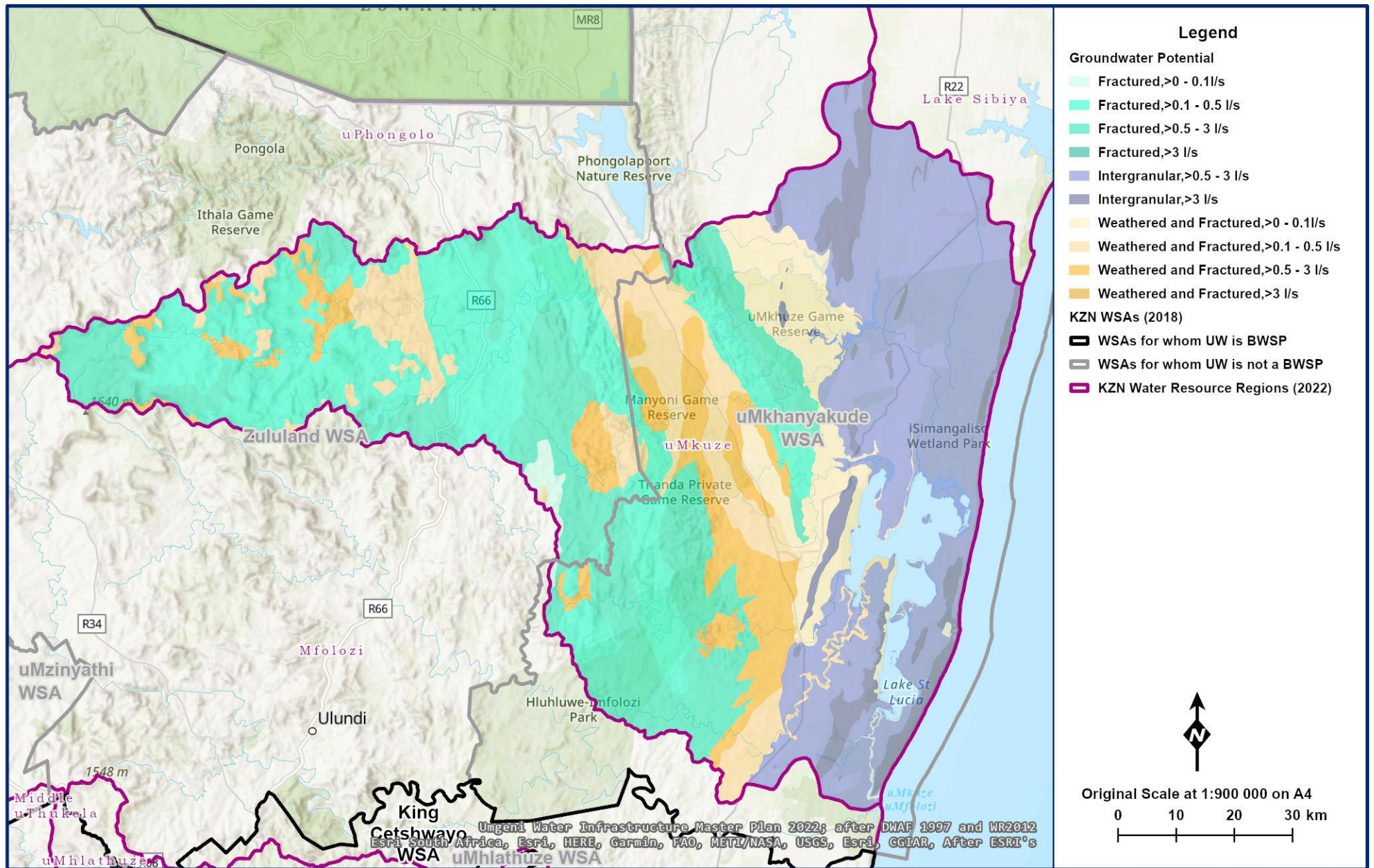

Figure 17.36 Groundwater potential in the uMkhuzo Region (MDB 2020, Umgeni Water 2021, after DWAF 1997 and WR2012).



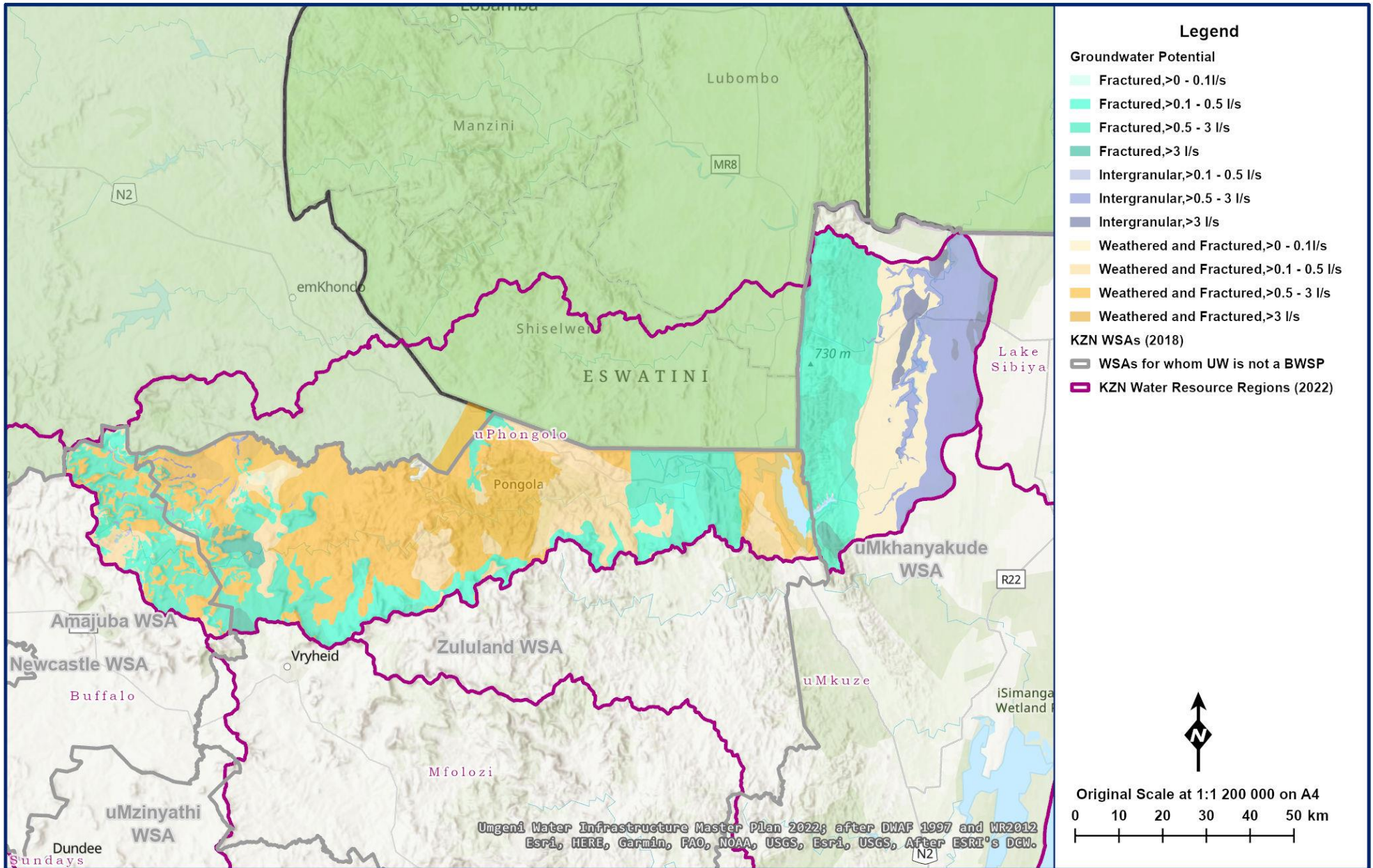

Figure 17.37 Groundwater potential in the Phongola Water Resource Region (MDB 2020, Umgeni Water 2022, after DWA 1997 and WR2012).



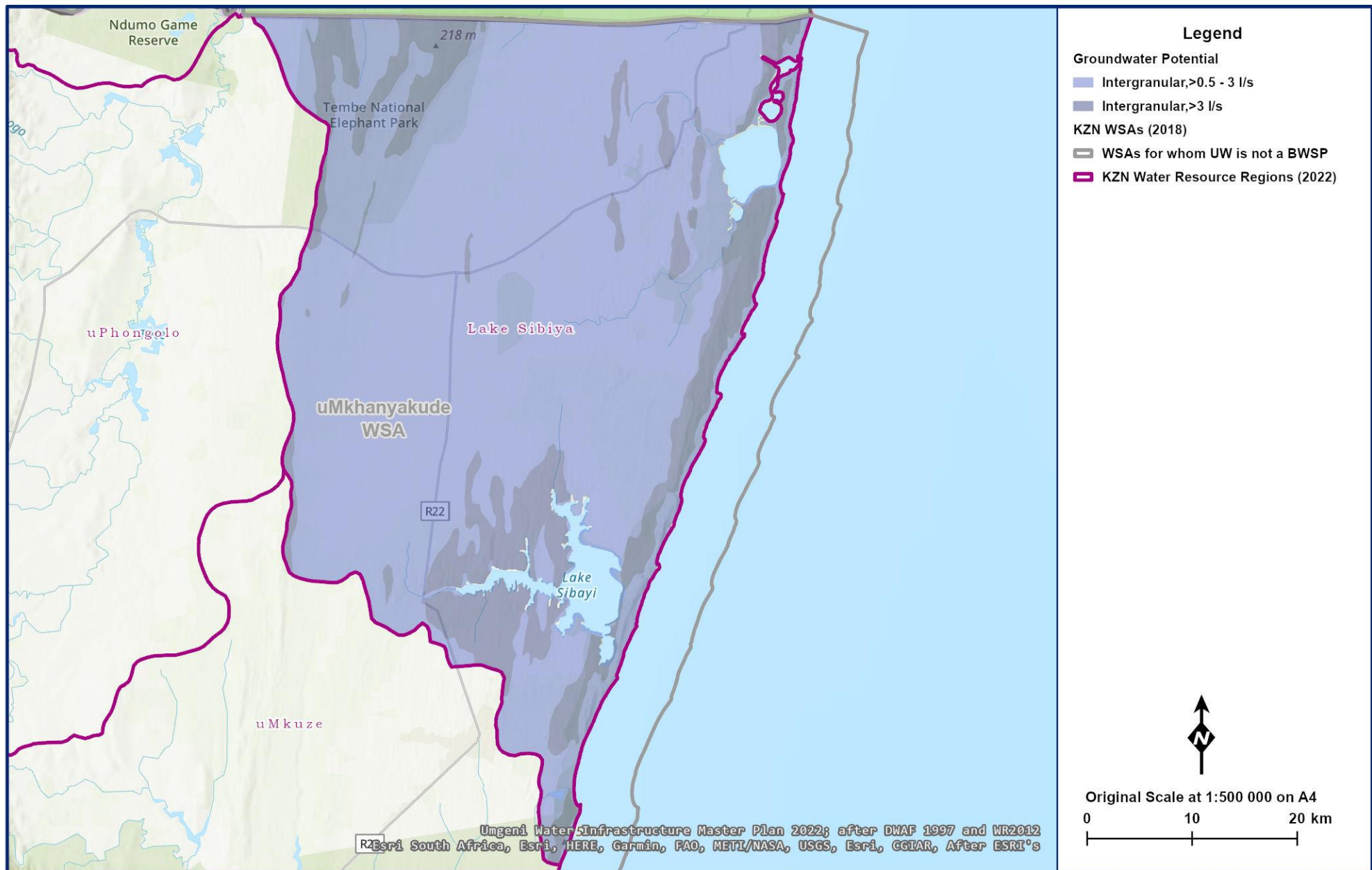

Figure 17.38 Groundwater potential in the Lake Sibaya Water Resource Region (MDB 2020, Umgeni Water 2022, after DWAF 1997 and WR2012).

## 18.1.2 Reserve

### (a) uMkhuze Water Resource Region

The impact of the Ecological Water Requirements on the yield of the catchments in the uMkhuze Water Resource Region is uncertain. However, the winter and summer low flow Ecological Reserve, based on the desktop method, is 2 million m<sup>3</sup> for the four driest months and 11 million m<sup>3</sup> for the eight wettest months (Zululand DM ZD-WSDP, 2004).

The present ecological status of the uMkhuze River is generally a class C. The recommended ecological category is a class C which means the current river ecological status must be maintained (DWS, 2015).

### (b) uPhongolo Water Resource Region

The uPhongolo River discharges into the floodplains downstream of the Pongolapoort Dam and, as a result, the environmental flows of this river are critical to maintaining the ecological health of this resource. A rapid assessment of the Ecological Reserve was carried out for the Pongolapoort and Bivane Dams and an operating rule has been developed to ensure an appropriate magnitude of water is released from the Pongolapoort Dam to meet social and environmental requirements on the flood plains. These releases reduce the yield of the Pongolapoort Dam substantially (by about 250 million m<sup>3</sup>/annum).

The present ecological status of the uPhongolo River is generally a class C. The recommended ecological category is a class C which means that the current river ecological status must be maintained (DWS, 2015).

### (c) Lake Sibaya Water Resource Region

Godfrey and Todd (2002) state that the present ecological status for Lake Sibaya is as follows:

**Habitat Integrity: Category B:** this is largely natural. There have been small impacts due to a) Mseleni Mission b) the Research Station c) new rest camps and a hotel near the western arm. The road to Mabibi was rebuilt in early 1980.

**Biotic Integrity: Category A:** this is unmodified and natural. Notwithstanding minor disturbances to the habitat of the lake, its biological component has proved resilient. The faunal structure is unique - freshwater and estuarine animals are found in the same lake. There is no other natural freshwater body in South Africa exhibiting this feature.

Based on the study by Godfrey and Todd (2002) the importance and sensitivity rating of the lake and the fact that it is included within the Greater St Lucia World Heritage site, the appropriate Management Class for the lake is set as a Category A.

Due to the present physical state of the lake, and associated non-supply risk, it is recommended that a Water Resource Classification and Resource Quality Objectives study is commissioned to reassess the lake's present state against its recommended ecological state.

## 18.1.3 Existing Water Resource Infrastructure and Yields

### (a) uMkhuze Water Resource Region

The water resources of the uMkhuze Water Resource Region are mostly undeveloped, with only a number of farm dams for irrigation purposes. The domestic and irrigation (largest water user in the catchment) water requirements are dependent on run-of-river yields. These vary significantly between the summer months and the winter months for the same level of assurance of supply.

The Hluhluwe Dam (**Figure 17.39** and **Table 17.38**) is the only significant dam in the catchment. It has a storage capacity of 25.89 million m<sup>3</sup> and estimates of the historical firm yield range from 8.5 million m<sup>3</sup>/annum to 23 million m<sup>3</sup>/annum based on various reports (Department of Water Affairs, 2004). A yield of 13.5 million m<sup>3</sup>/annum (**Table 17.39**) is adopted for this IMP, as per the 2011 DWS Reconciliation Strategy Study.

The total water resource available in the uMkhuze catchment is approximately 74 million m<sup>3</sup>/annum, after the allowance of the Ecological Reserve, irrigation return flows, the contribution of groundwater, and the transfer of water from Pongolapoort Dam for the Charl Senekal Trust (Umgeni Water, 2019:36).

The Hluhluwe River is one of the water sources in the catchment as it supplies the Hluhluwe Supply Area downstream of the Hluhluwe Dam. The Hluhluwe River is said to be the part of the uMkhuze Catchment that is currently oversubscribed, primarily due to overuse in the uMkhuze sub-catchment. The river flows into the iSimangaliso Wetland Park and, as a result, protection of the Ecological Reserve is important (Umgeni Water, 2019: 23).

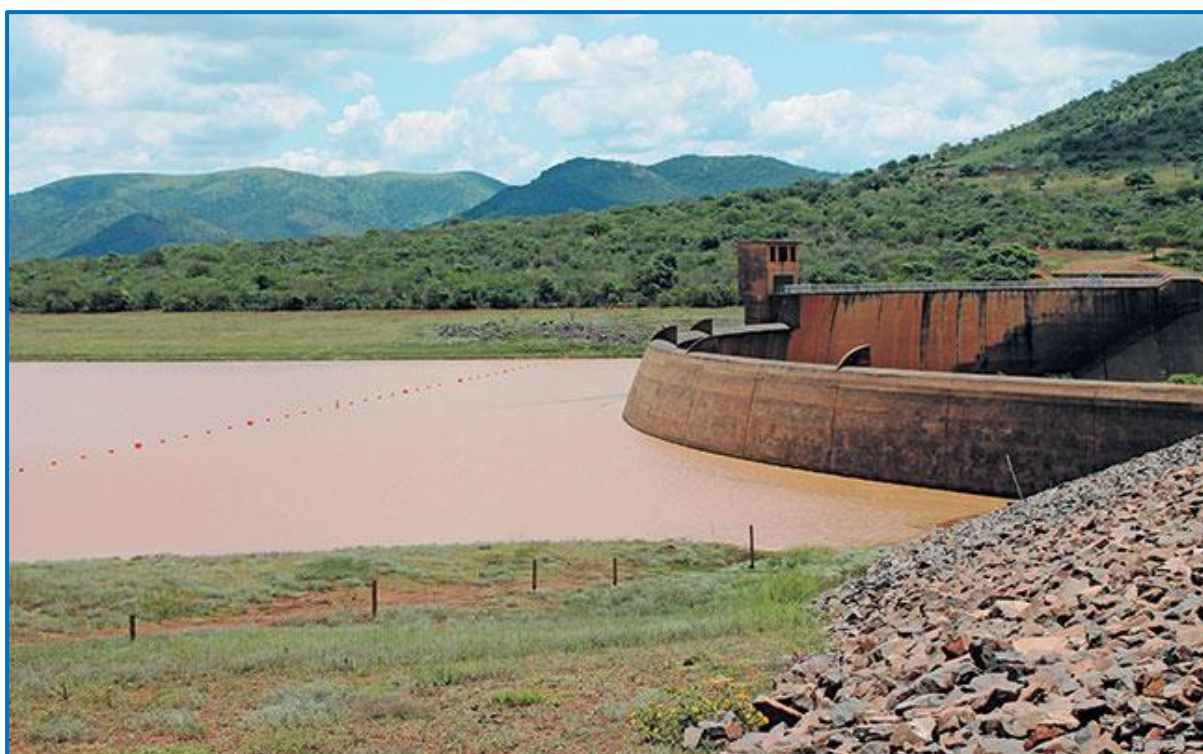

Figure 17.39 Hluhluwe Dam (Lloyd Phillips 2017:  
<https://www.farmersweekly.co.za/agri-business/empowerment/hluhluwe-farmers-assist-community-in-crisis/>)

**Table 17.38 Hluhluwe Dam (DWS 2018: Hydrographic Surveys Dams Database, DWS 2019: List of Registered Dams Database, WR2012).**

<b>Catchment Details</b>	
Incremental Catchment Area:	456 km <sup>2</sup> <sup>a</sup>
Total Catchment Area:	456 km <sup>2</sup> <sup>a</sup>
Mean Annual Precipitation:	769 mm <sup>b</sup>
Mean Annual Runoff:	28.28 million m <sup>3</sup> <sup>b</sup>
Annual Evaporation:	1450 mm <sup>b</sup>
<b>Dam Characteristics</b>	
Gauge Plate Zero:	Unknown at this stage
Full Supply Level:	80.74 mASL <sup>c</sup>
Net Full Supply Capacity:	25.8927 million m <sup>3</sup> <sup>c</sup>
Spillway Height:	33 m <sup>c</sup>
Dead Storage:	Unavailable
Total Capacity:	25.9 million m <sup>3</sup> <sup>c</sup>
Original Measured Dam Capacity:	29.658 million m <sup>3</sup> (1978) <sup>d</sup>
Second Measured Dam Capacity:	28.775 million m <sup>3</sup> (1985) <sup>d</sup>
Third Measured Dam Capacity:	25.893 million m <sup>3</sup> (2000) <sup>d</sup>
Surface Area of Dam at Full Supply Level:	3.64 km <sup>2</sup> <sup>c</sup>
Dam Type:	Arch and Earth fill <sup>c</sup>
Material Content of Dam Wall:	
Crest Length:	Crest length: 750 m <sup>e</sup> Spillway Section: 232 m <sup>e</sup> Non-Spillway Section: 517 m <sup>e</sup>
Type of Spillway:	Uncontrolled Ogee <sup>c</sup>
Capacity of Spillway:	1590 <sup>f</sup>
Date of Completion:	1965 <sup>c</sup>
Date of Last Area Capacity Survey:	2000
Date of Next Area Capacity Survey:	2014 (Overdue)

<sup>a</sup> Quaternary Catchment's calculate geometry tool in ArcGIS.

<sup>b</sup> WR2012.

<sup>c</sup> DWS List of Registered Dams Database (April 2019).

<sup>d</sup> DWS Hydrographic Surveys Dams Database (2018).

<sup>e</sup> Measured in Google Earth.

<sup>f</sup> SANCOLD

**Table 17.39 Hluhluwe Dam Yields (DWS, 2016).**

Dam	Historical Firm Yield (Mm <sup>3</sup> /a)	Stochastic Yield (Mm <sup>3</sup> /a)	
		1:50	1:100
Hluhluwe Dam	15.5	11.6	10.5



## (b) uPhongolo Water Resource Region

The main surface water resources include the Bivane (**Figure 17.40, Table 17.40**) and Pongolapoort Dams (**Figure 17.41, Table 17.41**), on Bivane and uPhongolo rivers, respectively, that account for 88% of the available water resources. The water resources of the uPhongolo catchments are fully developed through the Pongolapoort Dam. This dam is a 2.5 MAR dam which produces a large yield from the substantial runoff of the uPhongolo catchments. There is no further scope for increasing the yield. Surplus yield is currently available although the quantum is uncertain and will remain so until the environmental requirements/releases are completely determined. The Bivane Dam was constructed in the Bivane catchment to increase the assurance of supply to irrigators upstream of the Pongolapoort Dam (Zululand DM ZD-WSDP, 20004).

The seasonal pattern of storage in the Pongolapoort Dam is not typical of most dams. A significant flood release typically occurs in the month of October to flood the Makhathini Flats (the floodplain below the uPhongolo Dam). The yield characteristics associated with the dam take this seasonal pattern into account, particularly as the available storage and thus critical period reduces. As the flood release itself is curtailed as storage volumes decrease, the seasonal pattern will change. As a modern approach, the seasonal pattern was revised to align with a likely allocation of water based on the short-term yield available for the selected storage. This required an iterative approach.

The Pongolapoort Dam has a storage capacity of 2 267 million m<sup>3</sup>, and a historical firm yield of 530 million m<sup>3</sup>/annum. However, some of the yield is released to maintain the Makhathini floodplain. The current operating rule for the floodplain results in a yield impact of 250 million m<sup>3</sup>/annum. Besides meeting the water requirements of South Africa, the Pongolo River is an internationally shared watercourse and some of the water is released to meet the international obligations in accordance with the Interim Inco-Maputo Agreement. The historical firm yield was reviewed by DWS (2021) and was found to be 443 million m<sup>3</sup>/annum (DWS, 2021).



**Figure 17.40** Bivane Dam - Source (<http://www.bestfishingspots.co.za/dam>)



**Table 17.40 Characteristics of Bivane Dam**

<b>Catchment Details</b>	
<b>Incremental Catchment Area:</b>	1595 km <sup>2</sup> <sup>a</sup>
<b>Total Catchment Area:</b>	1595 km <sup>2</sup> <sup>a</sup>
<b>Mean Annual Precipitation:</b>	838 mm <sup>b</sup>
<b>Mean Annual Runoff:</b>	267.3 million m <sup>3</sup> <sup>b</sup>
<b>Annual Evaporation:</b>	1400 mm <sup>b</sup>
<b>Dam Characteristics</b>	
<b>Gauge Plate Zero:</b>	669.8 mASL <sup>d</sup>
<b>Full Supply Level:</b>	742 mASL <sup>d</sup>
<b>Spillway Height:</b>	72.2 m <sup>c</sup>
<b>Net Full Supply Capacity:</b>	115 million m <sup>3</sup> <sup>c</sup>
<b>Dead Storage:</b>	million m <sup>3</sup>
<b>Total Capacity:</b>	115 million m <sup>3</sup> <sup>c</sup>
<b>Surface Area of Dam at Full Supply Level:</b>	6.90 km <sup>2</sup> <sup>d</sup>
<b>Original Measured Dam Capacity</b>	115 million m <sup>3</sup> <sup>c</sup>
<b>Dam Type:</b>	Double Curvature Concrete Arch <sup>c</sup>
<b>Crest Length:</b>	Crest Length: 223 m <sup>d</sup> Spillway Section: 57 m <sup>d</sup> Non-Spillway Section: 166 m <sup>d</sup>
<b>Type of Spillway:</b>	Uncontrolled Ogee <sup>c</sup>
<b>Capacity of Spillway:</b>	3800 m <sup>3</sup> /s
<b>Date of Completion:</b>	2000 <sup>c</sup>
<b>Date of Area Capacity Survey:</b>	2011 <sup>c</sup>
<b>Date of next Area Capacity Survey:</b>	2026 <sup>f</sup>

<sup>a</sup> Sum of the Quaternary Catchments using statistics tool in ArcGIS.

<sup>b</sup> WR2012 Database of Quaternary Catchment Information.

<sup>c</sup> DWS List of Registered Dams Database (April 2019).

<sup>d</sup> Measured on Google Earth.

<sup>e</sup> SANCOLD

<sup>f</sup> DWS communication



Figure 17.41 Pongolapoort Dam (<https://www.royaljozini.com/pongolapoort-dam-some-history/>)

**Table 17.41 Characteristics of Pongolapoort Dam.**

<b>Catchment Details</b>	
<b>Incremental Catchment Area:</b>	6219 km <sup>2 a</sup>
<b>Total Catchment Area:</b>	7814 km <sup>2 a</sup>
<b>Mean Annual Precipitation:</b>	581 mm <sup> b</sup>
<b>Mean Annual Runoff:</b>	903.3 million m <sup>3 b</sup>
<b>Annual Evaporation:</b>	1500 mm <sup> b</sup>
<b>Dam Characteristics</b>	
<b>Gauge Plate Zero:</b>	42 mASL <sup> d</sup>
<b>Full Supply Level:</b>	137.2 mASL <sup> d</sup>
<b>Spillway Height:</b>	89 m <sup> c</sup>
<b>Net Full Supply Capacity:</b>	2267.06 million m <sup>3 d</sup>
<b>Dead Storage:</b>	233.85 million m <sup>3</sup>
<b>Total Capacity:</b>	2267.06 million m <sup>3 d</sup>
<b>Surface Area of Dam at Full Supply Level:</b>	132.728 km <sup>2 c</sup>
<b>Original Measured Dam Capacity</b>	2500.91 million m <sup>3 (1973) d</sup>
<b>Second Measured Dam Capacity</b>	2445.25 million m <sup>3 (1984) d</sup>
<b>Third Measured Dam Capacity</b>	2267.06 million m <sup>3 (2001) d</sup>
<b>Dam Type:</b>	Arch <sup> c</sup>
<b>Crest Length:</b>	Crest Length: 451 m <sup> e</sup> Spillway Section: 130 m <sup> e</sup> Non-Spillway Section: 321 m <sup> e</sup>
<b>Type of Spillway:</b>	Ogee <sup> c</sup>
<b>Capacity of Spillway:</b>	5700 m <sup>3/s</sup> <sup> f</sup>
<b>Date of Completion:</b>	1973 <sup> c</sup>
<b>Date of Area Capacity Survey:</b>	2001 <sup> d</sup>
<b>Date of next Area Capacity Survey:</b>	2016 <sup> g</sup>

<sup>a</sup> Sum of the Quaternary Catchments using statistics tool in ArcGIS

<sup>b</sup> WR2012 Database of Quaternary Catchment Information.

<sup>c</sup> DWS List of Registered Dams Database (April 2019).

<sup>d</sup> DWS Hydrographic Surveys Dams Database (2018).

<sup>e</sup> Measured on Google Earth.

<sup>f</sup> SANCOLD

<sup>g</sup> DWS Survey

### (c) Lake Sibaya Water Resource Region

Lake Sibaya has, over recent years, reduced in capacity. This is as a result of relative low precipitation levels, growing water demands from the timber industry and domestic abstractions by the local communities. The surface level of Lake Sibaya has dropped by at least 4 m over the last decade and is now at risk of being polluted by sea water (**Figure 17.42**).



Figure 17.42 Lake Sibayi (<https://infrastructurenews.co.za>)

## 18.1.4 Operating Rules

### (a) uMkhuze Water Resource Region

Domestic water requirements in the uMkhuze Water Resource Region are dependent on run-of-river abstractions. These run-of-river abstractions are also affected by seasonal flow patterns in the river.

A Drought Operating rule was developed for the Hluhluwe Dam and is based on modelled results from a planning analysis scenario where curtailments are imposed according to the water user classification and curtailment definition. The rule provides the basis for quantifying water restrictions that may be required in the system and these are based on the actual storage level in the dam on a May decision date. The decision is valid for a 12-month period and reviewed annually.

In cases where restrictions are implemented, but adequate rainfall is thereafter experienced during a wet season and causes a recovery in storage levels, those restrictions may be lifted. However, if drought conditions persist stricter curtailments are progressively imposed.

The rule for Hluhluwe Dam is presented in **Figure 17.43**. It should be noted that the rule was determined based on irrigation and domestic water use volumes for 2015 and would need to be revised if a significant change in water use is experienced.

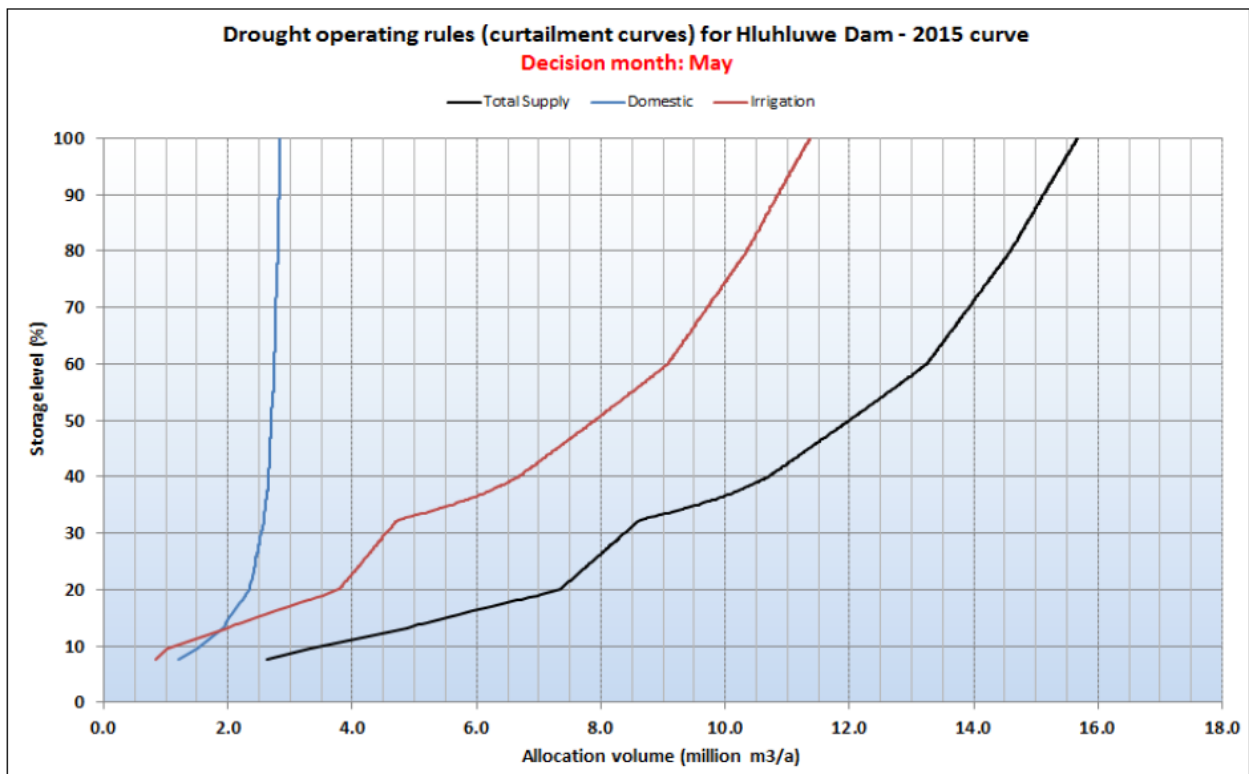

Figure 17.43 Hluhluwe Dam Drought Operating rules. DWS, 2016.

## (b) uPhongolo Water Resource Region

Pongolapoort Dam has environmental release operating rules but no water abstraction operating rules. The uPhongolo River does, however, experience deficits from time to time during winter months. This deficit is resolved by releases either from Bivane Dam or off channel storage to optimise summer high flows. DWS confirm a level of 70% of the full capacity as a trigger for the flood rule at the Pongolapoort Dam. The volume above this level can be released for the purposes of maintenance of the floodplain downstream. A constant release of 5 m<sup>3</sup>/s for downstream users, including international requirements, is made in low flow conditions.

An assessment of the safety of the Pongolapoort Dam by the DWS Dam Safety Office, after the 2004 floods, reported that the spillway capacity may not be sufficient to sustain a large flood. Recommendations were subsequently made to operate the dam at 80% of its storage capacity. This has an impact on the yield of dam with a reduction in yield of approximately 49 million m<sup>3</sup>/annum (UAP Phase 3, 2019). During a drought sequence, flood releases are only made if the dam level is above 70%. The flood release requires a peak flow rate of at least 800 m<sup>3</sup>/s to inundate the floodplain and if the storage is below 60% of the FSC then this flowrate cannot be achieved. The flood releases have not been made for six years due to the low level in the dam.

DWS undertakes an annual analyses to define and optimise the short-term (annual) allocation of water as part of the drought operating rules. The operating rule takes into consideration the storage level at a given point of time and provides a corresponding annual system yield (Table 17.42). A decision month of May takes into consideration the high summer rainfall and low winter rainfall for this area.



**Table 17.42 Pongolapoort Dam Short term yields (DWS, 2018).**

Starting Storage %	Yield ( $10^6 \text{ m}^3/\text{annum}$ )			
	1:100	1:50	1:20	1:10
100	770	825	920	1010
80	710	770	860	950
60	595	655	755	850
40	520	550	620	700
30	450	470	580	610
20	350	380	405	500
10	280	350	380	410

### (c) Lake Sibaya Water Resource Region

Meyer and Godfrey (2003) found that the maximum water level fluctuations recorded for Lake Sibaya are a minimum of 18 and maximum 20 mASL, representing a volume change of roughly 165 million  $\text{m}^3$ . Based on the recorded long-term lake levels from gauging stations W7R001 A03, and the ecological requirements, the lake reserve levels have been defined by DWS and are presented in **Table 17.43**.

**Table 17.43 Lake Sibayi water levels**

	Lake Water Level [masl]	Equivalent Lake Volume [million $\text{m}^3$ ]
Current full supply level	20.0	858.2
Maintenance minimum water level	19.6	802.2
Maintenance minimum dry season water level	18.9	752.7
Drought minimum water level	18.0	693.2

## 18.2 Supply Systems

### 18.2.1 Description of the uMkhuze, Uphongolo and Lake Sibaya Water Supply Systems

Mhlathuze Water is acting as an Implementing Agent (IA) for Umkhanyakude District Municipality (UKDM) on several of the regional water supply projects within the DM. They are also involved as a bulk water supplier in King Cetshwayo District Municipality to the south of uMkhanyakude. In 2017 UKDM requested Mhlathuze Water to fund and facilitate the compilation of a district-wide Water Master Plan for the DM to enable integrated and sustainable water supply to its consumers.

UKDM is currently served by a large number of small and medium-sized borehole schemes or surface water schemes through package treatment plants. There are only a few significant water treatment Plants (WTPs) that have the potential to be used as regional treatment facilities namely; Jozini (40 Mℓ/day under construction), Shemula (20 Mℓ/day recently commissioned augmenting existing 7 Mℓ/day capacity) and Mtubatuba (24 Mℓ/day).

The total system losses or non-revenue water (NWR) in 2008 from the uMkhuze -Ubombo Water Supply Scheme area were estimated at 2.1 Mℓ/day (0.75 million m<sup>3</sup>/a), or 66%, based on water use and operating practices. This estimate was based on the 2008 consumption figures. The high-water losses are mainly due to leakages at the service reservoirs.

### 18.2.2 uMkhuze Water Supply Supply

uMkhuze is situated in the town of uMkhuze within UKDM. The uMkhuze supply area includes the uMkhuze Town and Extends to Ubombo and the surrounding Ubombo Mountains. The raw water source for the uMkhuze WTP (**Figure 17.44**, **Table 17.44**) is the uPhongolo Dam. Raw water is pumped from uPhongolo Dam into the Blackie Dam (Charl Senekal Dam) and then pumped (**Table 17.45**) through a 160mm diameter rising main (**Table 17.46**) to the uMkhuze River. The Charl Senekal Trust has a raw water abstraction license of 3.1 Mℓ/day. The uMkhuze WTP is a 1.5 Mℓ/day plant with a conventional process of flocculent dosage, sedimentation, and filtration.

The uMkhuze-Ubombo bulk pipeline extends from outskirts of uMkhuze towards uMkhuze town and the potable water rising main from uMkhuze WTP towards Bethesda Hospital Reservoir (Ubombo Reservoir) (**Table 17.47**) crossing the uMkhuze River. The bulk line from Ubombo WTP, sourced from 3 boreholes, augment the supply to Bethesda Reservoir. The supple area includes the Bethesda Hospital Reservoir, commercial and household settlements including a limited supply extended beyond the rural town. Pipe sizes are currently unknown but will be verified with the latest asset register.

The uMkhuze Supply System is shown in **Figure 17.45**.



Figure 17.44 uMkhuze WTP ((Google Earth 2020: website).

**Table 17.44 Characteristics of the uMkhuze WTP**

<b>WTP Name:</b>	uMkhuze WTP
<b>System:</b>	Mkhuze Supply System
<b>Maximum Design Capacity:</b>	1.5 Mℓ/day upgraded to 4.5Mℓ/day
<b>Current Utilisation:</b>	1.5 Mℓ/day
<b>Raw Water Storage Capacity:</b>	1 Mℓ/day
<b>Raw Water Supply Capacity:</b>	*3 Mℓ/day
<b>Pre-Oxidation Type:</b>	None
<b>Primary Water Pre-Treatment Chemical:</b>	Polymeric Coagulant
<b>Total Coagulant Dosing Capacity:</b>	10 ℓ/hour*
<b>Rapid Mixing Method:</b>	Conventional Paddle Flash Mixer
<b>Clarifier Type:</b>	Circular
<b>Number of Clarifiers:</b>	2
<b>Total Area of all Clarifiers:</b>	*50 m <sup>2</sup>
<b>Total Capacity of Clarifiers:</b>	1.2 Mℓ/day
<b>Filter Type:</b>	Pressure Sand Filters
<b>Number of Filters:</b>	2
<b>Filter Floor Type</b>	Filter Sand
<b>Total Filtration Area of all Filters</b>	*40 m <sup>2</sup>
<b>Total Filtration Design Capacity of all Filters:</b>	4 m <sup>3</sup> /hr
<b>Total Capacity of Backwash Water Tanks:</b>	0m <sup>3</sup>
<b>Total Capacity of Sludge Treatment Plant:</b>	Sludge removed periodically by desludge into sludge lagoons.
<b>Capacity of Used Washwater System:</b>	None
<b>Primary Post Disinfection Type:</b>	Sodium Hypochlorite
<b>Disinfection Dosing Capacity:</b>	2.5 ℓ/hr
<b>Disinfectant Storage Capacity:</b>	20 ℓ tanks
<b>Total Treated Water Storage Capacity:</b>	1 Mℓ

\*Information needs verification

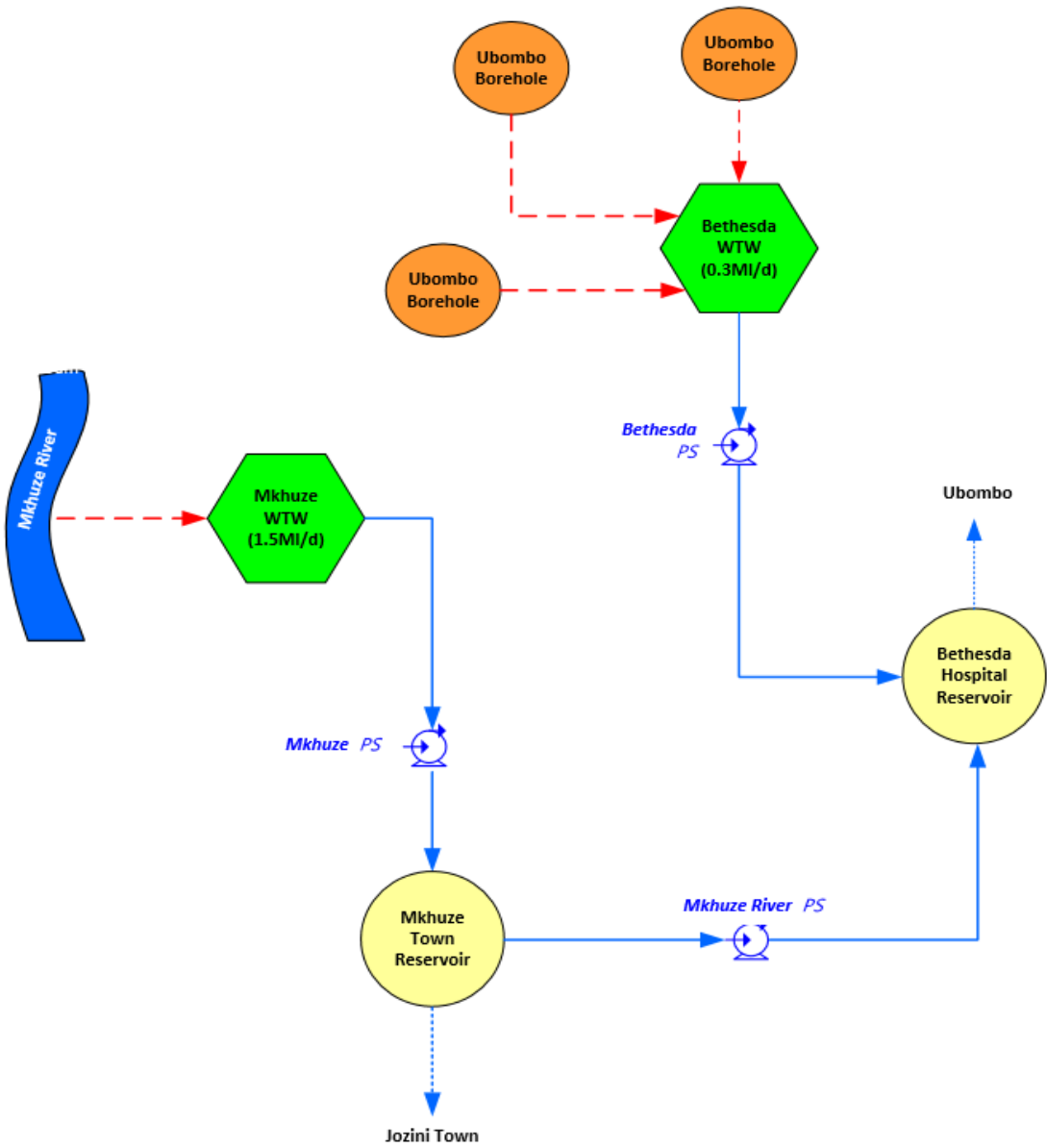

Figure 17.45 Layout of uMkhuze WTP Supply System



**Table 17.45 Pump Details**

System	Pump Station Name	Number of Pumps		Pump Description	Supply From	Supply To	Static Head (m)	Duty Head (m)	Duty Capacity (Mℓ/day)
		Number of Duty Pumps	Number of Standby Pumps						
uMkhuze	Mkhuze River PS	2	0		Mkhuze River	Mkhuze WTP	8*	10*	2.5
uMkhuze	Mkhuze PS	2	0		Mkhuze WTP	Mkhuze Town Res	12*	15*	1.0*
uMkhuze	Mkhuze River PS	2	0		Mkhuze River PS	Bethesda Hospital Res	97*	100*	1.0*

\*These figures are estimates and must be verified

**Table 17.46 Pipeline Details**

System	Pipeline Name	From	To	Length (km)	Nominal Diameter (mm)	Material	Capacity (Mℓ/day)	Age (years)
uMkhuze	uMkhuze raw water	UMkhuze River	UMkhuze WTP	0.01	100	Steel	1.01	42
uMkhuze	uMkhuze pumping main	UMkhuze WTP	UMkhuze PS	0.08	100	Steel	1.01	42
uMkhuze	uMkhuze pumping main	UMkhuze PS	UMkhuze Town Res	3.0	100	Steel	1.01	42
uMkhuze	uMkhuze River pumping	UMkhuze Town Res***	UMkhuze River PS	7.0	100	Steel	1.01	42
uMkhuze	uMkhuze River pumping	UMkhuze River PS	Bethesda Hospital Res	3.8	100	Steel	1.01	42

\*Capacity based on 1.5 m/s \*\*Capacity based on 1.5 m/s #Age be verified

**Table 17.47 Reservoir Details**

System	Reservoir Site	Reservoir Name	Capacity (Mℓ)	Function	TWL (mASL)	FL (mASL)
uMkhuze	uMkhuze WTP	uMkhuze WTP	1.5*	Terminal	128*	124
uMkhuze	uMkhuze Town	uMkhuze Town Res	1.0*	Terminal	138*	134
uMkhuze	Bethesda Hospital	Bethesda Hospital Res	1.0*	Distribution	592*	588

\*These figures are estimates and must be verified.

### 18.2.3 Hlobane/Coronation Water Supply System

Hlobane is positioned approximately 25 km north east of Vryheid on the road to Louwsburg and Pongola. The Hlobane WTP (**Figure 17.46**, **Figure 17.47** and **Table 17.48**) is a 2 Mℓ/day conventional process with flocculant dosage, sedimentation, and filtration. However, it is unusual in that it comprises elevated steel tanks rather than concrete structures. The works is not a package plant but all the units are free-standing tanks prefabricated in steel with the larger tanks welded together on site. The incoming water is pumped (**Table 17.49**) through a raw water pipeline (**Table 17.50**) to the elevated clarifiers from where it flows by gravity to the filters. After the filters the water is chlorinated and then flows to a treated water sump. It is then pumped again to the high-level storage reservoir (**Table 17.51**), which is also a steel tank in prefabricated sections. The Hlobane WTP receives raw water from the Hlobane Dam positioned a few hundred meters away. The water is pumped from the dam by pumps located at the Raw Water Pump Station.

Coronation is positioned about 40 km east of Vryheid on the road to Louwsburg and Pongola. The 0.4 Mℓ/day WTP (**Figure 17.48**) is a conventional process with flocculent dosage, sedimentation, and filtration. The works is a conventional plant with concrete tanks. The incoming water is pumped to an elevated storage tank from where it overflows to an elevated clarifier and then flows via gravity to the elevated rapid gravity filter. From there the water is chlorinated and flows to the treated water reservoir. This plant is in close proximity to the Hlobane BWSS and the Coronation Dam is on the same river as the Hlobane Dam. Zululand DM plan to consolidate the smaller plants with larger regional schemes. Raw water is sourced from the Coronation Dam a few kilometres from the WTP. This raw water is pumped to the treatment plant.

No projects are currently planned as the Coronation scheme is under revision and the scheme has water source challenges.

In evaluating whether the existing infrastructure would meet the demand for 2050, the current water source is insufficient. It is proposed that once a new source has been identified, the water treatment plant would need to be upgraded and the bulk distribution and storage be increased.



Figure 17.46 Aerial View of the Hlobane WTP (Google Earth 2020: website).



Figure 17.47 Hlobane WTP (Google Earth 2020: website).



**Figure 17.48** Aerial view of Coronation WTP (Google Earth 2020: website).

**Table 17.48 Characteristics of the Hlobane/Coronation WTP's**

<b>WTP Name:</b>	Hlobane WTP	Coronation WTP
<b>System:</b>	UMkhuze Bulk Supply System	UMkhuze Bulk Supply System
<b>Maximum Design Capacity:</b>	3.6 Ml/day	0.4 Ml/day
<b>Current Utilisation (January 2020):</b>	1.6 Ml/day	0.4 Ml/day

Additional Information Unavailable

Figure 17.49 shows a schematic of the Hlobane/Coronation Supply System.

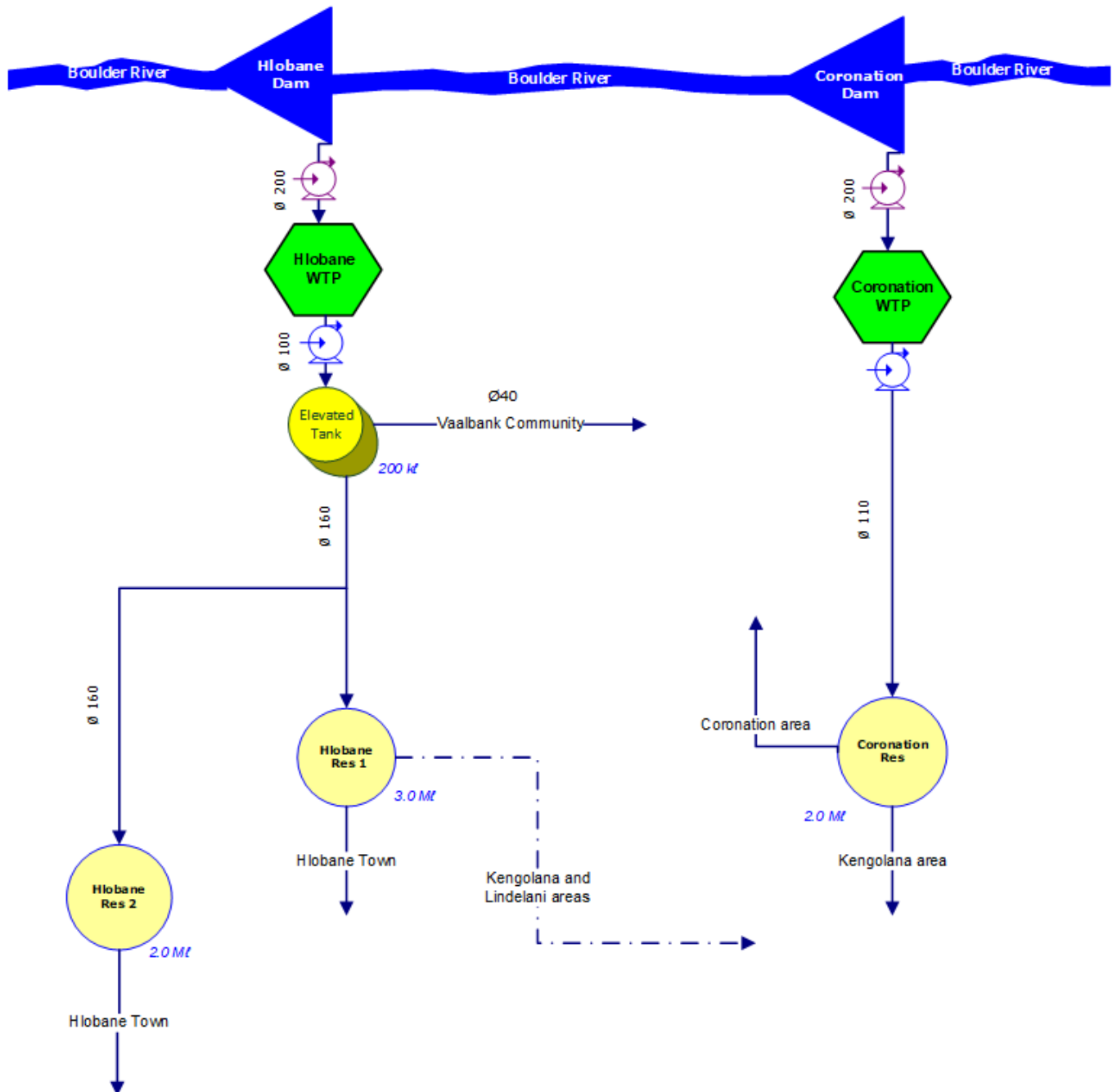

**Figure 17.49 Schematic of the Hlobane/Coronation Supply System.**



**Table 17.49 Pump Details**

System	Pump Station Name	Number of Pumps		Pump Description	Supply From	Supply To	Static Head (m)	Duty Head (m)	Duty Capacity (ML/day)
		Number of Duty Pumps	Number of Standby Pumps						
Hlobane	Raw water PS	1	1		Hlobane Dam	Hlobane WTP	35	45	3.5
Hlobane	Hlobane PS	1	1		Hlobane WTP	Elevated Tank	26	35	2
Coronation	Raw water PS	1	1		Coronation Dam	Coronation WTP	74	85	0.4
Coronation	Coronation PS	1	1		Coronation WTP	Coronation Res	31	40	0.4

**Table 17.50 Pipeline Details**

System	Pipeline Name	From	To	Length (km)	Nominal Diameter (mm)	Material	Capacity (ML/day)	Age (years)
Hlobane Coronation	Hlobane raw water	Hlobane Dam	Hlobane WTP	0.73	200	Steel	4.07*	42
Hlobane Coronation	Hlobane potable water	Hlobane WTP	Elevated Tank	0.05	100	Steel	1.01*	42
Hlobane Coronation	Potable water	Elevated Tank	Hlobane Res 1	2.95	160	uPVC	3.47**	42
Hlobane Coronation	Potable water	Hlobane Res 1	Hlobane Res 2	1.5	160	uPVC	3.47**	42
Hlobane Coronation	Coronation raw water	Coronation Dam	Coronation WTP	3.82	200	uPVC	4.07*	42
Hlobane Coronation	Potable water	Coronation WTP	Coronation Res	2.95	110	uPVC	1.23*	42

\*Capacity based on 2 m/s \*\*Capacity based on 1.5 m/s

**Table 17.51 Reservoir Details**

System	Reservoir Site	Reservoir Name	Capacity (Mℓ)	Function	TWL (mASL)	FL (mASL)
Hlobane Coronation	Hlobane Coronation	Hlobane Res 1	3.0	Terminal	1253*	1248
Hlobane Coronation	Hlobane Coronation	Hlobane Res 2	2.0	Terminal	1322*	1317
Hlobane Coronation	Hlobane Coronation	Hlobane Elevated Tank	0.2	Distribution	1279*	1274
Hlobane Coronation	Hlobane Coronation	Coronation Res	2.0	Terminal	1310*	1305

\*These figures are estimates and have to be verified

## 18.2.4 Description of the uPhongolo System

### (a) Overview of the uPhongolo System

Zululand DM is one of the 14 Water Services Authorities in KwaZulu-Natal Province. The Zululand District is positioned in the northern region of the KwaZulu-Natal Province and covers an area of approximately 14 810 km<sup>2</sup>. The system is bounded by Swaziland and Mpumalanga Province to the north, Amajuba DM to the west, Umkhanyakude DM to the east and Umzinyathi and King Cetshwayo District Municipalities to the south. Approximately half of the area is under the jurisdiction of traditional authorities while the remainder is divided between commercially owned farms and conservation areas. The District comprises the following five local municipalities as depicted in **Figure 17.50**).

- eDumbe (KZ 261)
- uPhongolo (KZ 262)
- Abaqulusi (KZ 263)
- Nongoma (KZ 265)
- Ulundi (KZ 266)



## (a) Edumbe Water Treatment Supply System

The main source of water supply for the Edumbe (Paulpietersburg) Water Supply Scheme is the Edumbe Dam situated in the headwaters of the Egoda River, a tributary of the uPhongolo River in Quaternary Catchment W42D. The registered municipal water use for the Edumbe Water Supply Scheme from the system comprising the Edumbe Dam, is 0.53 million m<sup>3</sup>/annum according to the DWS WARMS records. No other downstream users depend on Edumbe Dam. The water allocation for this scheme is registered in the name of Edumbe Local Municipality, which is the Water Service Provider (WSP). The registered water use for the scheme should be transferred to Zululand DM as the WSA. There are no known water quality problems at the Edumbe WTP (**Figure 17.51** and **Table 17.52**). The quality of the resource upstream of the Edumbe Dam appears to be good because of the limited land use in the catchment although some areas do have commercial forestry.

The Edumbe WTP is the only plant, which supplies treated water to the Edumbe Water Supply Scheme area (**Table 17.53**, **Table 17.54** and **Table 17.55**). The total peak hydraulic design capacity of the Edumbe WTP is 3.5 Mℓ/day. The average annual capacity of the WTP is estimated to be 2.7 Mℓ/day. The average annual capacity of the WTP is sufficient to meet the immediate water requirements of the Edumbe Water Supply Scheme area.



**Figure 17.51** Aerial view of Edumbe Water Treatment Plant (Google Earth 2020: website).

**Table 17.52 Characteristics of the Edumbe WTP.**

<b>WTP Name:</b>	Edumbe WTP
<b>System:</b>	Phongolo Supply System
<b>Maximum Design Capacity:</b>	3.5 Mℓ/day
<b>Current Utilisation:</b>	2.7 Mℓ/day
<b>Raw Water Storage Capacity:</b>	0 Mℓ
<b>Raw Water Supply Capacity:</b>	4.0 Mℓ/day
<b>Pre-Oxidation Type:</b>	None
<b>Primary Water Pre-Treatment Chemical:</b>	Polymeric Coagulant
<b>Total Coagulant Dosing Capacity:</b>	13 ℓ/hour
<b>Rapid Mixing Method:</b>	Conventional Paddle Flash Mixer
<b>Clarifier Type:</b>	Dortmund Manual Clarifiers
<b>Number of Clarifiers:</b>	3
<b>Total Area of all Clarifiers:</b>	314.6 m <sup>2</sup>
<b>Total Capacity of Clarifiers:</b>	4.0 Mℓ/day
<b>Filter Type:</b>	Rapid Gravity Sand Filters
<b>Number of Filters:</b>	3
<b>Filter Floor Type</b>	Laterals with Nozzles
<b>Total Filtration Area of all Filters</b>	109.13 m <sup>2</sup>
<b>Total Filtration Design Capacity of all Filters:</b>	4.0 Mℓ/day
<b>Total Capacity of Backwash Water Tanks:</b>	0m <sup>3</sup>
<b>Total Capacity of Sludge Treatment Plant:</b>	None
<b>Capacity of Used Washwater System:</b>	0 Mℓ/day
<b>Primary Post Disinfection Type:</b>	Chlorine gas
<b>Disinfection Dosing Capacity:</b>	10 kg/hr Chlorinator
<b>Disinfectant Storage Capacity:</b>	
<b>Total Treated Water Storage Capacity:</b>	5.5 Mℓ

Figure 17.52 shows a schematic of the Edumbe Supply System.



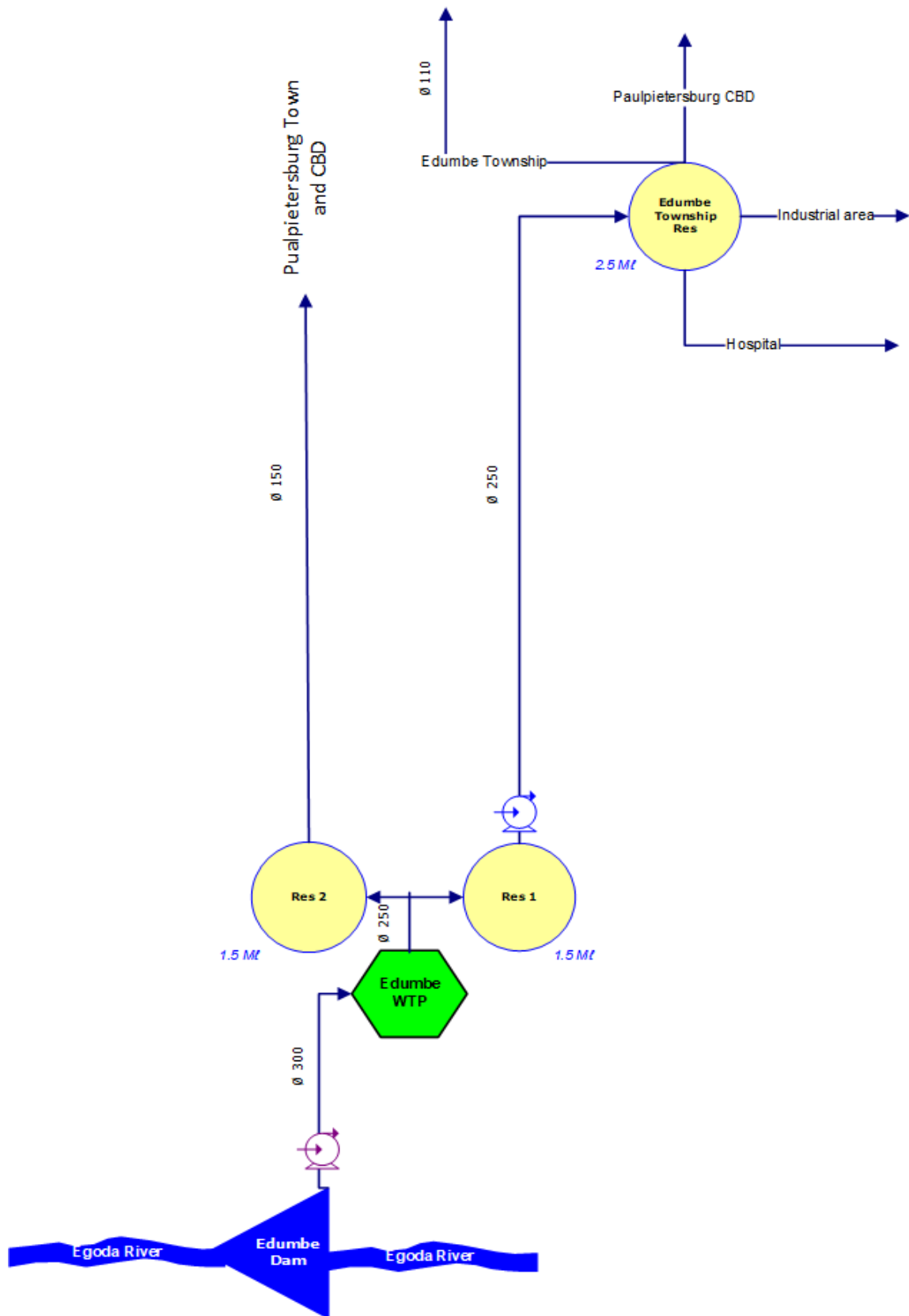

Figure 17.52 Schematic of the Edumbe Supply System

**Table 17.53 Pump details: Edumbe Supply System**

System	Pump Station Name	Number of Pumps		Pump Description	Supply From	Supply To	Static Head (m)	Duty Head (m)	Duty Capacity (Mℓ/day)
		Number of Duty Pumps	Number of Standby Pumps						
Edumbe	Edumbe Raw water PS	1	1	Franklin 65250 CIM-S	Edumbe Dam	Edumbe WTP	50	55**	4
Edumbe		1	1	KSB ETA 100-400	Res 1	Edumbe Township Res	1	15**	3.6#

- \*\* These figures are based on calculated head loss

**Table 17.54 Reservoir details: Edumbe BWSS.**

System	Reservoir Site	Reservoir Name	Capacity (Mℓ)	Function	TWL (aMSL)	FL (aMSL)
Edumbe	Edumbe	Res 1	1.5	Terminal	1170*	1165*
Edumbe	Edumbe	Res 2	1.5	Distribution	1170*	1165*
Edumbe	Edumbe	Edumbe Township Res	2.5	Terminal	1170	1165*

\*These figures are estimates and must be verified

**Table 17.55 Pipeline details: Edumbe BWSS.**

System	Pipeline Name	From	To	Length (km)	Nominal Diameter (mm)	Material	Capacity (Mℓ/day)	Age (years)
Edumbe	Raw water pipeline	Edumbe Dam	Edumbe WTP	2.16	300	Steell	9.16**	41
Edumbe	Potable water pipeline	Edumbe WTP	Res 1 and 2	0.087	250	Steel	8.48*	41
Edumbe	Potable water pipeline	Res 1	Paulpietersburg CBD and Town	2.290	150	Steel	3.05*	41

System	Pipeline Name	From	To	Length (km)	Nominal Diameter (mm)	Material	Capacity (Mℓ/day)	Age (years)
Edumbe	Potable water pipeline	Res 2	Edumbe Township Res	4.180	250	Steel	6.36**	41

Based on a velocity of 2 m/s      \*\* Based on a velocity of 1.5 m/s    # Age need to be verified

## (b) Frischgewaagd Water Treatment Supply System

The Frischgewaagd WTP (**Figure 17.53** and **Table 17.56**) is a conventional rapid gravity filtration works. The peak hydraulic design capacity of the WTP was determined to be 2 Mℓ/day based on the registered volume of water for the plant. The average annual demand is 1.48 Mℓ/day.

The Frischgewaagd WTP sources its raw water from the uPhongolo River via an abstraction pumping system (**Table 17.57**).

The treated water is then distributed (**Table 17.59**) to four storage reservoirs (**Table 17.58**), which supplies potable water to the communities.

**Figure 17.53** shows an aerial view of the Frischgewaagd WTP and storage three of the storage reservoirs.



**Figure 17.53** Aerial view of Frischgewaagd Water Treatment Plant (Google Earth 2020: website).

**Table 17.56 Characteristics of the Frischgewaagd WTP.**

<b>WTP Name:</b>	Frischgewaagd WTP
<b>System:</b>	Phongolo Supply System
<b>Maximum Design Capacity:</b>	2.0 Mℓ/day
<b>Current Utilisation:</b>	1.48 Mℓ/day
<b>Raw Water Storage Capacity:</b>	0 Mℓ
<b>Raw Water Supply Capacity:</b>	2.0 Mℓ/day
<b>Pre-Oxidation Type:</b>	None
<b>Primary Water Pre-Treatment Chemical:</b>	Polymeric Coagulant
<b>Total Coagulant Dosing Capacity:</b>	13 ℓ/hour
<b>Rapid Mixing Method:</b>	Conventional Paddle Flash Mixer
<b>Clarifier Type:</b>	Dortmund Manual Clarifiers
<b>Number of Clarifiers:</b>	2
<b>Total Area of all Clarifiers:</b>	236.88 m <sup>2</sup>
<b>Total Capacity of Clarifiers:</b>	2.0 Mℓ/day
<b>Filter Type:</b>	Pressure Filters
<b>Number of Filters:</b>	7
<b>Filter Floor Type</b>	Laterals with Nozzles
<b>Total Filtration Area of all Filters</b>	40.87 m <sup>2</sup>
<b>Total Filtration Design Capacity of all Filters:</b>	2.0 Mℓ/day
<b>Total Capacity of Backwash Water Tanks:</b>	0m <sup>3</sup>
<b>Total Capacity of Sludge Treatment Plant:</b>	None
<b>Capacity of Used Washwater System:</b>	0 Mℓ/day
<b>Primary Post Disinfection Type:</b>	Chlorine gas
<b>Disinfection Dosing Capacity:</b>	10 kg/hr Chlorinator
<b>Disinfectant Storage Capacity:</b>	
<b>Total Treated Water Storage Capacity:</b>	2.5 Mℓ

Figure 17.54 shows a schematic of the Frischgewaagd Supply System



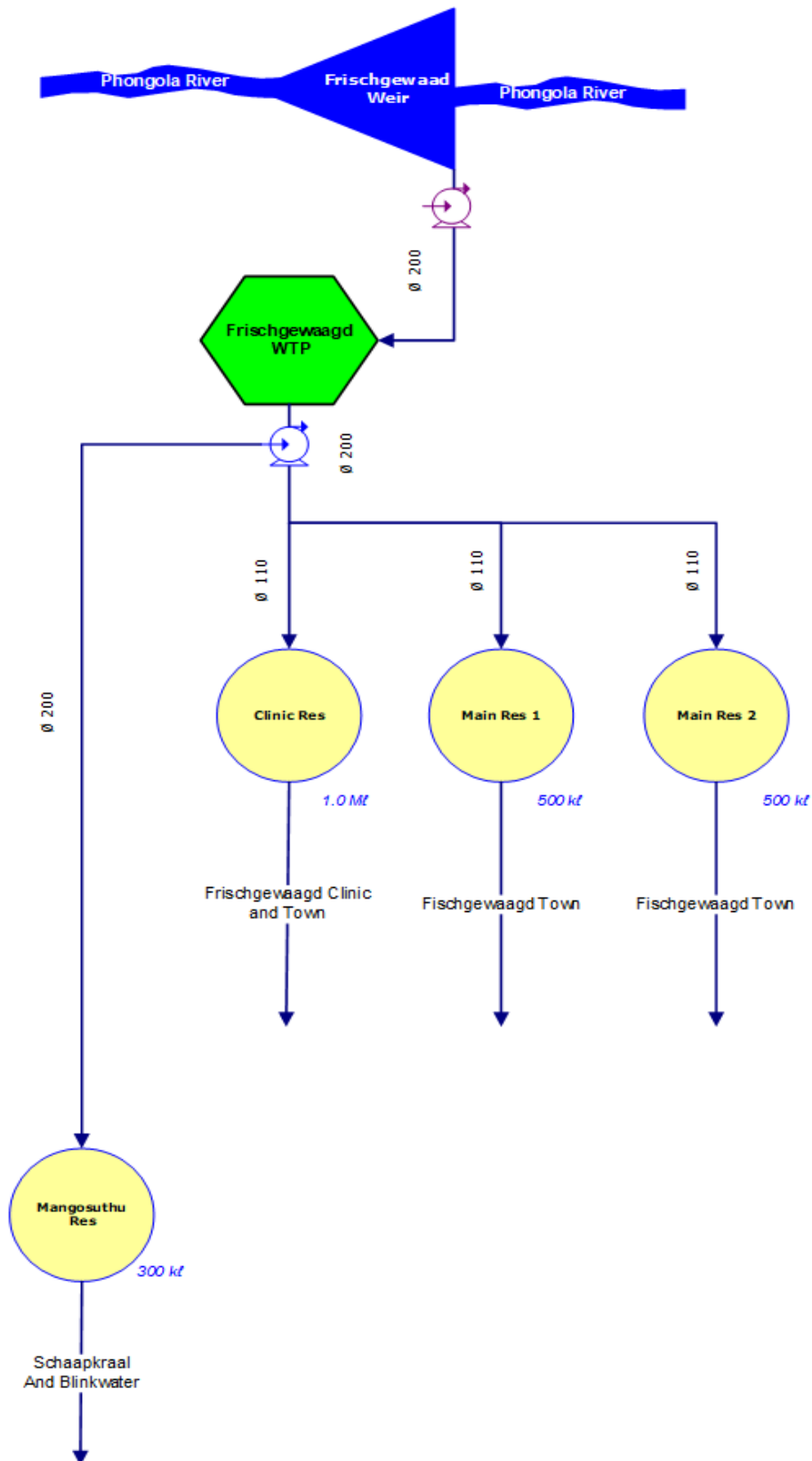

Figure 17.54 Schematic of Frischgewaagd WTP Supply System

**Table 17.57 Pump details: Frischgewaagd Supply System**

System	Pump Station Name	Number of Pumps		Pump Description	Supply From	Supply To	Static Head (m)	Duty Head (m)	Duty Capacity (Mℓ/day)
		Number of Duty Pumps	Number of Standby Pumps						
Frischgewaagd	Frischgewaagd Raw water PS	1	1	KSB WKLn 80/4	Phongolo River	Frischgewaagd WTP	222	230**	2
Frischgewaagd	Mangosuthu Pump Station	1	1	Pedrollo F 65/160B	Frischgewaagd WTP	Mangosuthu Res	37	50	0.864
Frischgewaagd	Clinic Pump Station	1	1	Pedrollo CPm 160B	Frischgewaagd WTP	Clinic Res	36	50	0.3168
Frischgewaagd	Main Reservoir Pump Station	1	1	Pedrollo F 65/160B	Frischgewaagd WTP	Main Res1/Main Res2	37	50	0.864

- \*\* These figures are based on calculated head loss

**Table 17.58 Reservoir details: Frischgewaagd BWSS.**

System	Reservoir Site	Reservoir Name	Capacity (Mℓ)	Function	TWL (aMSL)	FL (aMSL)
Frischgewaagd	Frischgewaagd	Res 1	0.5	Terminal	1055*	1050*
Frischgewaagd	Frischgewaagd	Res 2	0.5	Terminal	1055*	1050*
Frischgewaagd	Frischgewaagd	Clinic	1.0	Terminal	1057	1050*
Frischgewaagd	Frischgewaagd	Mangosuthu Res	0.3	Terminal	1097	1091*

\*These figures are estimates and must be verified

**Table 17.59 Pipeline details: Frischgewaagd BWSS.**

System	Pipeline Name	From	To	Length (km)	Nominal Diameter (mm)	Material	Capacity (Ml/day)	Age (years)
Frischgewaagd	Raw water pipeline	Phongolo River	Frischgewaagd WTP	3.6	200	Steell	4.07**	41#
Frischgewaagd	Potable water pipeline	Frischgewaagd WTP	Res 1, 2 and Clinic Res	0.087	110 for each reservoir	uPVC	1.23*	41#
Frischgewaagd	Potable water pipeline	Frischgewaagd WTP	Mangosuthu Res	3.234	200	uPVC	4.07*	41#

Based on a velocity of 2 m/s      \*\* Based on a velocity of 1.5 m/s    # Age need to be verified

## 18.2.5 Simdlangentsha Central Regional Bulk Water Supply Scheme (Belgrade BWSS)

### (a) Belgrade Water Treatment Supply System

The Belgrade (New) Water Treatment Plant is located in the town Belgrade in the Zululand District of Kwazulu-Natal. The Belgrade Water Supply Scheme is supplied from two sources namely a weir in the Mozana River and a small dam in the tributary of Mozana River near the water treatment plant.

The total peak hydraulic design capacity of the Belgrade WTP (**Figure 17.55** and **Table 17.60**) is estimated to be 1.5 Mℓ/day. The average annual flow rate of the plant is estimated to be 1.2 Mℓ/day. The current raw water abstraction from the Mozana River was estimated to be 1.36 Mℓ/day (0.5 million m<sup>3</sup>/a) assuming water losses from the raw water abstraction works pumping main as well as the water treatment losses.

Water is pumped (**Table 17.61**) from the WTP through rising mains (**Table 17.63**) to a number of distribution reservoirs (**Table 17.62**) in the system.

**Figure 17.55** shows an aerial view of the Belgrade WTP.



**Figure 17.55** Aerial view of Belgrade Water Treatment Plant (Google Earth 2020: website).

**Table 17.60 Characteristics of the Belgrade WTP.**

<b>WTP Name:</b>	Belgrade WTP
<b>System:</b>	Phongolo Supply System
<b>Maximum Design Capacity:</b>	1.5 Mℓ/day
<b>Current Utilisation:</b>	1.2 Mℓ/day
<b>Raw Water Storage Capacity:</b>	0 Mℓ
<b>Raw Water Supply Capacity:</b>	1.36 Mℓ/day
<b>Pre-Oxidation Type:</b>	None
<b>Primary Water Pre-Treatment Chemical:</b>	Polymeric Coagulant
<b>Total Coagulant Dosing Capacity:</b>	13 ℓ/hour
<b>Rapid Mixing Method:</b>	Conventional Paddle Flash Mixer
<b>Clarifier Type:</b>	Dortmund Manual Clarifiers
<b>Number of Clarifiers:</b>	4
<b>Total Area of all Clarifiers:</b>	236.88 m <sup>2</sup>
<b>Total Capacity of Clarifiers:</b>	2.0 Mℓ/day
<b>Filter Type:</b>	Pressure Filters
<b>Number of Filters:</b>	4
<b>Filter Floor Type</b>	Laterals with Nozzles
<b>Total Filtration Area of all Filters</b>	40.87 m <sup>2</sup>
<b>Total Filtration Design Capacity of all Filters:</b>	2.0 Mℓ/day
<b>Total Capacity of Backwash Water Tanks:</b>	0m <sup>3</sup>
<b>Total Capacity of Sludge Treatment Plant:</b>	None
<b>Capacity of Used Washwater System:</b>	0 Mℓ/day
<b>Primary Post Disinfection Type:</b>	Chlorine gas
<b>Disinfection Dosing Capacity:</b>	10 kg/hr Chlorinator
<b>Disinfectant Storage Capacity:</b>	
<b>Total Treated Water Storage Capacity:</b>	2.5 Mℓ

Figure 17.56 shows a schematic of the Belgrade Supply System



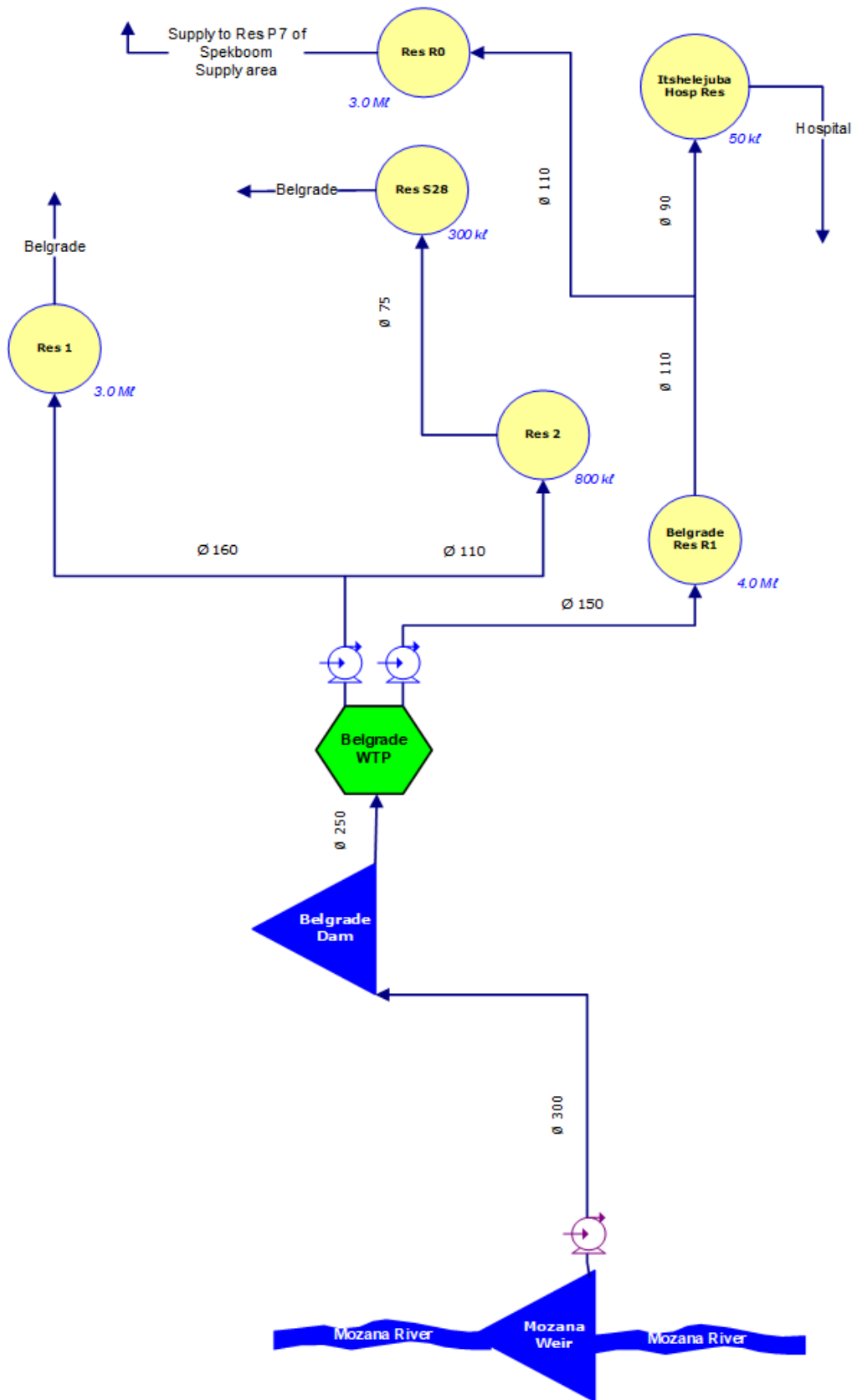

Figure 17.56 Schematic of Belgrade WTP Supply System

**Table 17.61 Pump details: Belgrade Supply System**

System	Pump Station Name	Number of Pumps		Pump Description	Supply From	Supply To	Static Head (m)	Duty Head (m)	Duty Capacity (Mℓ/day)
		Number of Duty Pumps	Number of Standby Pumps						
Belgrade	Mozane River abstraction	3	1	KSB KRT - F 80/250	Mozana Weir	Belgrade dam	134	140**	2
Belgrade	Mozane HL Station	2	2	KSB WKLn 80/4	Mozana Weir	Belgrade dam	134	150	0.3
Belgrade	Belgrade dam	1	1	Grundfos	Belgrade dam	Belgrade new WTP			
Belgrade	Belgrade old plant	1	1	KSB WKLn 50/3	Belgrade WTP	Res 1	81	90**	0.5
Belgrade	Belgrade old plant	1	1	KSB WKLn 50/4	Belgrade WTP	Res 2	93	100**	0.5
Belgrade	Belgrade new plant	1	1	KSB KWLn 150/5	Belgrade WTP	Belgrade Res R1	210		4.3

- \*\* These figures are based on calculated head loss

**Table 17.62 Reservoir details: Belgrade BWSS.**

System	Reservoir Site	Reservoir Name	Capacity (Mℓ)	Function	TWL (aMSL)	FL (aMSL)
Belgrade	Belgrade	Res 1	3.0	Terminal	944*	937*
Belgrade	Belgrade	Res 2	0.8	Balancing	956*	947*
Belgrade	Belgrade	Res R1	4.0	Distribution	1042*	1035*
Belgrade	Belgrade	Res R0	3.0	Distribution	914*	909*

\*These figures are estimates and must be verified

**Table 17.63 Pipeline details: Belgrade BWSS.**

System	Pipeline Name	From	To	Length (km)	Nominal Diameter (mm)	Material	Capacity (Ml/day)	Age (years)
Belgrade	Raw water pipeline	Mozana River	Belgrade Dam	5.6	300	Steell	9.16**	41#
Belgrade	Raw water pipeline	Belgrade Dam	Belgrade WTP	0.087	250	uPVC	8.48*	41#
Belgrade	Potable water pipeline	Belgrade WTP	Res 1	1.6	160	uPVC	2.6*	41#
Belgrade	Potable water pipeline	Belgrade WTP	Res 2	2.4	110	uPVC	1.23**	41#
Belgrade	Potable water pipeline	Belgrade WTP	Res R1	5.0	150	Steel	2.3**	41#
Belgrade	Potable water pipeline	Res R1	Res R0	9.0	110	uPVC	1.64*	41#

\* Based on a velocity of 2 m/s \*\* Based on a velocity of 1.5 m/s # Age need to be verified

## 18.2.6 Simdlangentsha East Regional Bulk Water Supply Scheme (Spekboom BWSS, uPhongolo BWSS)

### (a) Spekboom Water Treatment Supply System

The Spekboom Water Treatment Plant (**Figure 17.57**, **Table 17.64**) is located approximately 25km North West of the town of Pongola in the Zululand District of Kwazulu-Natal and supplies treated water to the settlement of Spekboom. Raw water is pumped (**Table 17.65**) from the Spekboom River and treatment takes place in a packaged plant consisting of a sedimentation tank and two pressure filters. Treated water is stored in a concrete reservoir (**Table 17.66**) on site before it is pumped, through rising mains (**Table 17.67**), to the reticulation network (**Figure 17.58**).

The maximum processing capacity of the package plant is 1.2 Mℓ/day.



**Figure 17.57** Aerial view of Spekboom Water Treatment Plant (Google Earth 2020: website).

**Table 17.64 Characteristics of the Spekboom WTP.**

<b>WTP Name:</b>	Spekboom WTP
<b>System:</b>	Phongolo Supply System
<b>Maximum Design Capacity:</b>	1.2 Mℓ/day
<b>Current Utilisation:</b>	1.2 Mℓ/day
<b>Raw Water Storage Capacity:</b>	0 Mℓ
<b>Raw Water Supply Capacity:</b>	1.2 Mℓ/day
<b>Pre-Oxidation Type:</b>	None
<b>Primary Water Pre-Treatment Chemical:</b>	Polymeric Coagulant
<b>Total Coagulant Dosing Capacity:</b>	13 ℓ/hour
<b>Rapid Mixing Method:</b>	Conventional Paddle Flash Mixer
<b>Clarifier Type:</b>	Dortmund Manual Clarifiers
<b>Number of Clarifiers:</b>	1
<b>Total Area of all Clarifiers:</b>	236.88 m <sup>2</sup>
<b>Total Capacity of Clarifiers:</b>	1.2 Mℓ/day
<b>Filter Type:</b>	Pressure Filters
<b>Number of Filters:</b>	2
<b>Filter Floor Type</b>	Laterals with Nozzles
<b>Total Filtration Area of all Filters</b>	40.87 m <sup>2</sup>
<b>Total Filtration Design Capacity of all Filters:</b>	1.2 Mℓ/day
<b>Total Capacity of Backwash Water Tanks:</b>	0m <sup>3</sup>
<b>Total Capacity of Sludge Treatment Plant:</b>	None
<b>Capacity of Used Washwater System:</b>	0 Mℓ/day
<b>Primary Post Disinfection Type:</b>	Chlorine gas
<b>Disinfection Dosing Capacity:</b>	10 kg/hr Chlorinator
<b>Disinfectant Storage Capacity:</b>	
<b>Total Treated Water Storage Capacity:</b>	2.5 Mℓ

Figure 17.58 shows a schematic of the Spekboom Supply System



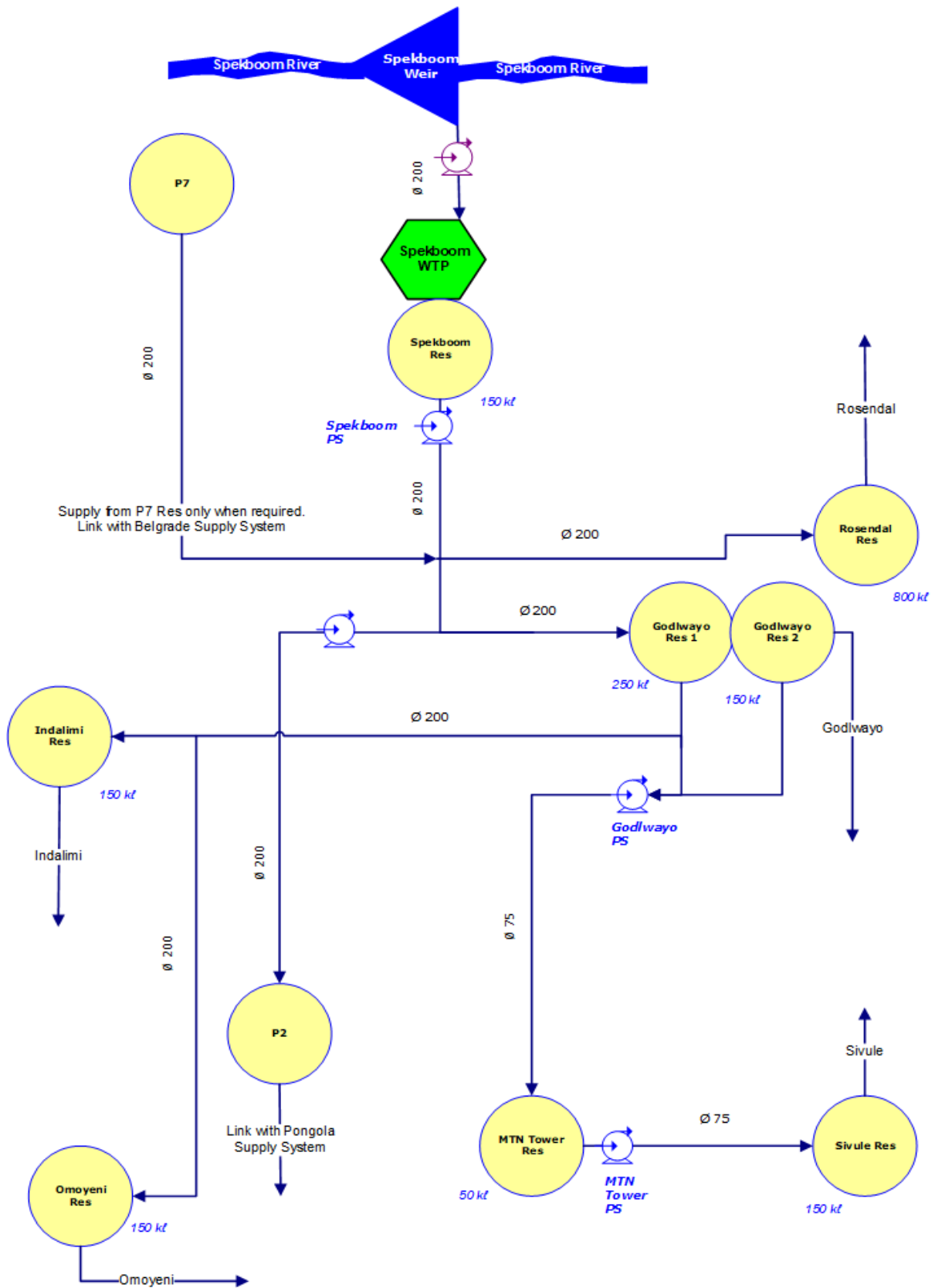

Figure 17.58 Schematic of Spekboom WTP Supply System

**Table 17.65 Pump details: Spekboom Supply System**

System	Pump Station Name	Number of Pumps		Pump Description	Supply From	Supply To	Static Head (m)	Duty Head (m)	Duty Capacity (Mℓ/day)
		Number of Duty Pumps	Number of Standby Pumps						
Spekboom	Spekboom Raw Water PS	2	1	Grundfos slv.80.100.75.2.5d.c	Spekboom Weir	Spekboom WTP	2	5**	1.5
Spekboom	Spekboom HL Pump Station	2	0	Mono pump pp5402	Spekboom WTP	Godlwayo Res & Bedle Res	84	90**	0.2
Spekboom	Godlwayo PS	2	0	Mono pump pp0404	Godlwayo Res	MTN Tower Res	96	100**	0.2
Spekboom	MTN Tower PS	1	1	Mono pump pp0404	MTN Tower Res	Sivule Res	172	178**	0.2

- \*\* These figures are based on calculated head loss

**Table 17.66 Reservoir details: Spekboom BWSS.**

System	Reservoir Site	Reservoir Name	Capacity (Mℓ)	Function	TWL (aMSL)	FL (aMSL)
Spekboom	Spekboom	Godlwayo Res 1	0.25	Distribution	663*	658*
Spekboom	Spekboom	Godlwayo Res 2	0.15	Distribution	663*	658*
Spekboom	Spekboom	Rosendal Res	0.15	Distribution	704*	699*
Spekboom	Spekboom	MTN Tower Res	0.05	Balancing	759*	754*
Spekboom	Spekboom	Sivule Res	0.15	Terminal	931*	926*
Spekboom	Spekboom	Indalimi Res	0.15	Terminal	726*	722*
Spekboom	Spekboom	Omoyeni	0.15	Terminal	687*	683*

\*These figures are estimates and must be verified

**Table 17.67 Pipeline details: Spekboom BWSS.**

System	Pipeline Name	From	To	Length (km)	Nominal Diameter (mm)	Material	Capacity (Ml/day)	Age (years)
Spekboom	Raw water pipeline	Spekboom River	Spekboom WTP	0.01	200	uPVC	4.07**	42#
Spekboom	Potable water pipeline	Spekboom WTP	Rosendal Res	2.18	200	uPVC	4.07**	42#
Spekboom	Potable water pipeline	Spekboom WTP	Godlwayo Res Complex	2.0	200	uPVC	4.07**	42#
Spekboom	Potable water pipeline	Godlwayo Res	MTN Tower Res	1.7	75	uPVC	0.5**	42#
Spekboom	Potable water pipeline	MTN Tower Res	Sivule Res	2.2	75	uPVC	0.5**	42#
Spekboom	Potable water pipeline	Godlwayo Res	Indalini Res	1.0	200	uPVC	5.42*	42#
Spekboom	Potable water pipeline	Godlwayo Res	Omoyeni Res	1.7	200	uPVC	5.42*	42#

Based on a velocity of 2 m/s      \*\* Based on a velocity of 1.5 m/s    # Age need to be verified

## (b) uPhongolo Water Treatment Supply System

The uPhongolo Water Treatment Plant (**Figure 17.59, Table 17.68**) is located south of the town of Pongola in the Zululand District of Kwazulu-Natal. The WTP receives raw water from an old irrigation canal system that was built for farm plantations. Some of the water from the canal collects in two ponds outside the water works before it gravitates into the head of works where the flow of water is metered.

For approximately four weeks of the year, when the canal is undergoing planned maintenance, raw water is pumped from a pump station, which abstracts water from the uPhongolo River and delivers directly into the canal, just upstream of a gauging sluice. The pump station and rising main only supply when the main irrigation canal is not operational. The plant operator estimates the capacity of the existing raw water pumping system at 8.5 Mℓ/day. This is sufficient to meet the average annual daily water treatment capacity of 8 Mℓ/day but not the peak requirements.

There is one water treatment plant, the Phongola Regional WTP, currently in operation, that is supplying treated water to the Simdlangentsha East Regional Water Supply Scheme area, which includes the town of Pongola. The design capacity of the uPhongolo WTP is for an average annual daily flow rate of 8 Mℓ/day. The maximum flow rate of the treatment plant is 12 Mℓ/day. The current treated water production from the uPhongolo Regional WTP alone was 8.37 Mℓ/day (3.05 million m<sup>3</sup>/annum) in 2019, which represents 105% of its design capacity and as a result the WTP is now being over-utilised. This is as a result of communities, south west of the supply area, being connected to the scheme (these areas were largely dependent on the local water supplies, which became unreliable).



**Figure 17.59 Aerial view of Phongola Water Treatment Plant**

**Table 17.68 Characteristics of the Phongola WTP.**

<b>WTP Name:</b>	Phongola WTP
<b>System:</b>	Phongola Supply System
<b>Maximum Design Capacity:</b>	12 Mℓ/day
<b>Current Utilisation:</b>	8.7 Mℓ/day
<b>Raw Water Storage Capacity:</b>	8.7Mℓ
<b>Raw Water Supply Capacity:</b>	8.5 Mℓ/day
<b>Pre-Oxidation Type:</b>	None
<b>Primary Water Pre-Treatment Chemical:</b>	Polymeric Coagulant
<b>Total Coagulant Dosing Capacity:</b>	13 ℓ/hour
<b>Rapid Mixing Method:</b>	Conventional Paddle Flash Mixer
<b>Clarifier Type:</b>	Dortmund Manual Clarifiers
<b>Number of Clarifiers:</b>	14
<b>Total Area of all Clarifiers:</b>	236.88 m <sup>2</sup>
<b>Total Capacity of Clarifiers:</b>	12 Mℓ/day
<b>Filter Type:</b>	Slow Sand Filters
<b>Number of Filters:</b>	14
<b>Filter Floor Type</b>	Laterals with Nozzles
<b>Total Filtration Area of all Filters</b>	40.87 m <sup>2</sup>
<b>Total Filtration Design Capacity of all Filters:</b>	12 Mℓ/day
<b>Total Capacity of Backwash Water Tanks:</b>	Unknown
<b>Total Capacity of Sludge Treatment Plant:</b>	None
<b>Capacity of Used Washwater System:</b>	0 Mℓ/day
<b>Primary Post Disinfection Type:</b>	Chlorine gas
<b>Disinfection Dosing Capacity:</b>	10 kg/hr Chlorinator
<b>Disinfectant Storage Capacity:</b>	
<b>Total Treated Water Storage Capacity:</b>	3.0 Mℓ

**Figure 17.60** shows a schematic of the Phongola Supply System. Water is pumped (**Table 17.69**) from the WTP through a 250mm diameter pipeline (**Table 17.71**) to a number of distribution reservoirs in the system (**Table 17.70**).



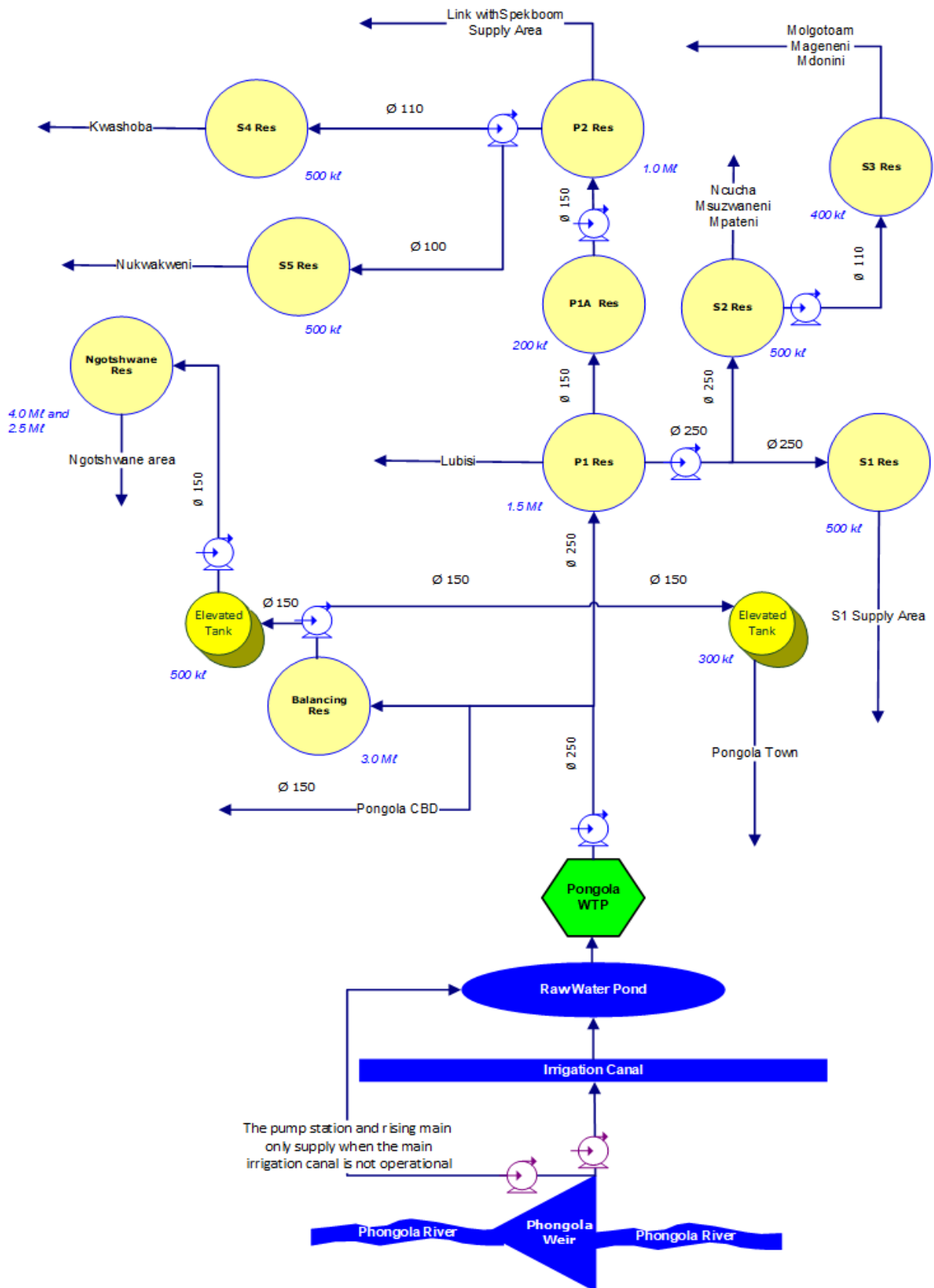

Figure 17.60 Schematic of Phongola WTP Supply System

**Table 17.69 Pump details: Phongola Supply System**

System	Pump Station Name	Number of Pumps		Pump Description	Supply From	Supply To	Static Head (m)	Duty Head (m)	Duty Capacity (ML/day)
		Number of Duty Pumps	Number of Standby Pumps						
Phongola	Raw water PS	1	1	Xylem 2201.012.0097 & Tsurumi KR 8822	Phongola River	Irrigation canal	36	43**	8
Phongola	Phongolo Raw Water PS	1	1	KSB LCC-M 80-300.2	Phongola Weir	Raw Water Pond			
Phongola	Pongola HL Pump Station	2	0	KSB ETA 125 - 50/1	Phongola WTP	Town Res	75.8	85**	4.8
Phongola	Pongola HL Pump Station	0	2	KSB ETA 125 - 50/2	Phongola WTP	Town Res	18	20**	2.5
Phongola	Ncotshana Tower Station	1	1	KSB WKLn 100/6	Town Res	Ncotshana Res	15	18**	1.2
Phongola	Simudlangentsha HL Station	2	2	KSB WKLn 80/3	Pongola WTP	P1 Pump Station	145	164**	2.5
Phongola	P1 Pump Station	2	1	KSB WKLn 65/3	Simudlangentsha HL Station	P1a	142	160**	1.1
Phongola	P1 Pump Station	2	1	KSB WKLn 32/10	Simudlangentsha HL Station	S1 Res	264	280**	0.177
Phongola	P1 Pump Station	1	1	KSB WKLn 80-4	Simudlangentsha HL Station	S2	171	180**	0.5
Phongola	P1 Pump Station	1	1	KSB WKLn 40/5	Simudlangentsha HL Station	S2	121	139**	0.5
Phongola	P1a Pump Station	2	1	KSB WKLn 65/5	P1 Pump Station	P2 Res	182	211**	3
Phongola	P2 Pump Station	2	1	KSB WKLn 40/4	P1a Pump Station	S4 Res	128	140**	0.5
Phongola	P2 Pump Station	2	1	KSB WKLn 32/8	P1a Pump Station	S5 Res	186	206**	0.5
Phongola	S2 Pump Station	2	1	KSB WKLn 32/7	S2 Pump Station	S3 Res	121	175	0.5

\* These figures are based on calculated head loss

**Table 17.70 Reservoir details: Phongola BWSS.**

System	Reservoir Site	Reservoir Name	Capacity (Mℓ)	Function	TWL (aMSL)	FL (aMSL)
Phongola	Phongola	Phongola Balancing Res	3.0	Balancing	350*	343*
Phongola	Phongola	Elevated Tank 1	0.5	Distribution	368*	360*
Phongola	Phongola	Elevated Tank 2	0.3	Terminal	362*	354.45*
Phongola	Phongola	P1 Res	1.5	Distribution	393*	386*
Phongola	Phongola	Ngotshwane Res	6.5	Terminal	413*	406*
Phongola	Phongola	S1 Res	0.5	Terminal	647*	641*
Phongola	Phongola	S2 Res	0.5	Distribution	564*	558*
Phongola	Phongola	S3 Res	0.4	Terminal	685*	679*
Phongola	Phongola	P1 A Res	0.2	Balancing	520*	514*
Phongola	Phongola	P2 Res	1.0	Distribution	711*	704*
Phongola	Phongola	S4 Res	0.5	Terminal	839*	833*
Phongola	Phongola	S5 Res	0.5	Terminal	897*	891*

\*These figures are estimates and must be verified

**Table 17.71 Pipeline details: Phongola BWSS.**

System	Pipeline Name	From	To	Length (km)	Nominal Diameter (mm)	Material	Capacity (Mℓ/day)	Age (years)
Phongola	Raw water pipeline	Phongola River	Phongola WTP	2.6	2 x 150	Steel	4.07**	42#
Phongola	Potable water pipeline	Phongola WTP	Phongola Balancing Tank	1.6	250	Steel	6.36**	42#
Phongola	Potable water pipeline	Phongola WTP	P1 Res	2.0	250	Steel	6.36**	42#
Phongola	Potable water pipeline	Balancing Tank	Elevated Tank 2	0.52	150	Steel	2.3**	42#
Phongola	Potable water pipeline	Elevated Tank 1	Ngotshwane Res	4.7	150	Steel	2.3**	42#
Phongola	Potable water pipeline	P1 Res	S1 Res	2.7	250	Steel	6.36**	42#
Phongola	Potable water pipeline	P1 Res	S2 Res	2.0	250	Steel	6.36**	42#
Phongola	Potable water pipeline	S2 Res	S3 Res	2.0	110	uPVC	1.23**	42#
Phongola	Potable water pipeline	P1 Res	P 1A Res	4.8	150	Steel	3.05*	42#
Phongola	Potable water pipeline	P1 A Res	P2 Res	3.2	150	Steel	2.3**	42#
Phongola	Potable water pipeline	P2 Res	S4 Res	2.4	110	Steel	1.23**	42#
Phongola	Potable water pipeline	P2 Res	S5 Res	3.6	100	Steel	1.02**	42#

Based on a velocity of 2 m/s

\*\* Based on a velocity of 1.5 m/s # Age need to be verified



## 18.2.7 Mjindi Water Treatment Supply System (0.35 Ml/day)

The Mjindi Water Treatment Plant (**Figure 17.61, Table 17.72**) is located North towards Mafefe along the S1834. The bulk pipeline branches on the D21 road towards the Biva community and also on the A1188 towards Maputaland.

Raw water is pumped (**Table 17.73**) from the uPhongolo River and treatment takes place in a small plant consisting of a sedimentation tank and three pressure filters. Treated water is stored in a jojo tank on site before it is distributed to the reticulation network through pipelines (**Table 17.74**) and reservoirs (**Table 17.75**).

The current operating capacity of the plant is 0.27 Ml/day.



**Figure 17.61** Aerial view of Mjindi Water Treatment Plant (Unknown source).

**Table 17.72 Characteristics of the Mjindi WTP.**

<b>WTP Name:</b>	Mjindi WTP
<b>System:</b>	uPhongolo Supply System
<b>Maximum Design Capacity:</b>	0.35 Mℓ/day
<b>Current Utilisation:</b>	0.27 Mℓ/day
<b>Raw Water Storage Capacity:</b>	1 Jojo tank
<b>Raw Water Supply Capacity:</b>	0.35 Mℓ/day
<b>Pre-Oxidation Type:</b>	None
<b>Primary Water Pre-Treatment Chemical:</b>	Polymeric Coagulant
<b>Rapid Mixing Method:</b>	Conventional Paddle Flash Mixer
<b>Clarifier Type:</b>	Plastic Clarifiers
<b>Number of Clarifiers:</b>	2 new & 1 old
<b>Total Capacity of Clarifiers:</b>	0.35 Mℓ/day
<b>Filter Type:</b>	Pressure Filters
<b>Number of Filters:</b>	3
<b>Filter Floor Type</b>	Filter Media
<b>Total Filtration Design Capacity of all Filters:</b>	0,35 Mℓ/day or 14,5m <sup>3</sup> /hr
<b>Total Capacity of Backwash Water Tanks:</b>	0m <sup>3</sup>
<b>Total Capacity of Sludge Treatment Plant:</b>	None
<b>Capacity of Used Washwater System:</b>	None
<b>Primary Post Disinfection Type:</b>	Sodium Hypochlorite
<b>Disinfection Dosing Capacity:</b>	*1.0 l/hr
<b>Disinfectant Storage Capacity:</b>	25 ℓ tank
<b>Total Treated Water Storage Capacity:</b>	1 Jojo storage tank

Figure 17.62 shows a schematic of the Mjindi Supply System

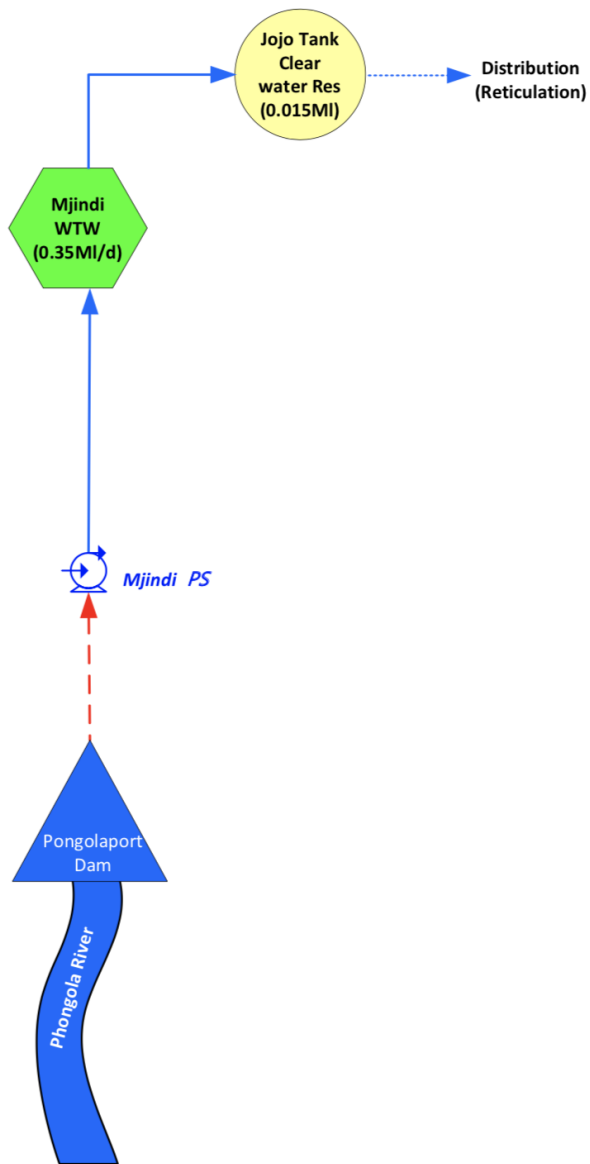

Figure 17.62 Schematic of Mjindi WTP Supply System

**Table 17.73 Mjindi Pump Details**

System	Pump Station Name	Number of Pumps		Pump Description	Supply From	Supply To	Static Head (m)	Duty Head (m)	Duty Capacity (Mℓ/day)
		Number of Duty Pumps	Number of Standby Pumps						
Phongola River	Mjindi PS	1	0		uPhongolo River	Mjindi WTP	71	73	0.35

**Table 17.74 Mjindi Pipeline Details**

System	Pipeline Name	From	To	Length (km)	Nominal Diameter (mm)	Material	Capacity (Mℓ/day)	Age (years)
Phongola River	Raw water pipeline	PhongolaPoort Dam	Mjindi WTP	0.2	80	uPVC	0.4	42#

**Table 17.75 Mjindi Reservoir Details**

System	Reservoir Site	Reservoir Name	Capacity (Mℓ)	Function	TWL (mASL)	FL (mASL)
Phongola River	Mjindi	Mjindi WTP	0,0015	Distribution	72	71

## 18.2.8 Nondebuya Water Treatment Supply System

The Nondabuya Water Treatment Plant Package Plant (**Figure 17.63, Table 17.76**) is located East of Jozini within the uMkhanyakude District Municipality of KwaZulu-Natal. The supply area extends North towards Kwasukela and West along the Mangqwashi River towards Ophondweni. The main source of supply to Nondabuya WTP is from the Phongola River. Nondebuya Clearwater Reservoir (**Table 17.78**) and Clearwater Pump Station is located in Nondebuya area. The current demand from the Nondebuya WTP exceeds the available supply volumes. Water is supplied from the WTP to two distribution reservoirs through a number of pipelines with details presented in (**Table 17.77**).

The current operating capacity of the plant is 0.3 Mℓ/day.



**Figure 17.63 Aerial view of Nondebuya Water Treatment Plant & Nondabuya Reservoirs (unknown source).**



**Table 17.76 Characteristics of the Nondebuya WTP.**

<b>WTP Name:</b>	Nondabuya WTP
<b>System:</b>	uPhongolo Supply System
<b>Maximum Design Capacity:</b>	0.3 Mℓ/day
<b>Current Utilisation:</b>	0.3 Mℓ/day
<b>Raw Water Storage Capacity:</b>	0.3 Mℓ
<b>Raw Water Supply Capacity:</b>	0.3 Mℓ/day
<b>Pre-Oxidation Type:</b>	None
<b>Primary Water Pre-Treatment Chemical:</b>	None
<b>Total Coagulant Dosing Capacity:</b>	None
<b>Rapid Mixing Method:</b>	None
<b>Clarifier Type:</b>	None
<b>Number of Clarifiers:</b>	None
<b>Total Area of all Clarifiers:</b>	None
<b>Total Capacity of Clarifiers:</b>	None
<b>Filter Type:</b>	Slow Sand Filters
<b>Number of Filters:</b>	2
<b>Filter Floor Type</b>	Filter Sand
<b>Total Filtration Area of all Filters</b>	m <sup>2</sup>
<b>Total Filtration Design Capacity of all Filters:</b>	0.3 Mℓ/day
<b>Total Capacity of Backwash Water Tanks:</b>	None
<b>Total Capacity of Sludge Treatment Plant:</b>	None
<b>Capacity of Used Washwater System:</b>	None
<b>Primary Post Disinfection Type:</b>	Sodium Hypochlorite
<b>Disinfection Dosing Capacity:</b>	None
<b>Disinfectant Storage Capacity:</b>	25 ℓ tank
<b>Total Treated Water Storage Capacity:</b>	2 tanks x 0.2Mℓ and 0.1Mℓ

Figure 17.64 shows a schematic of the Nondebuya Supply System

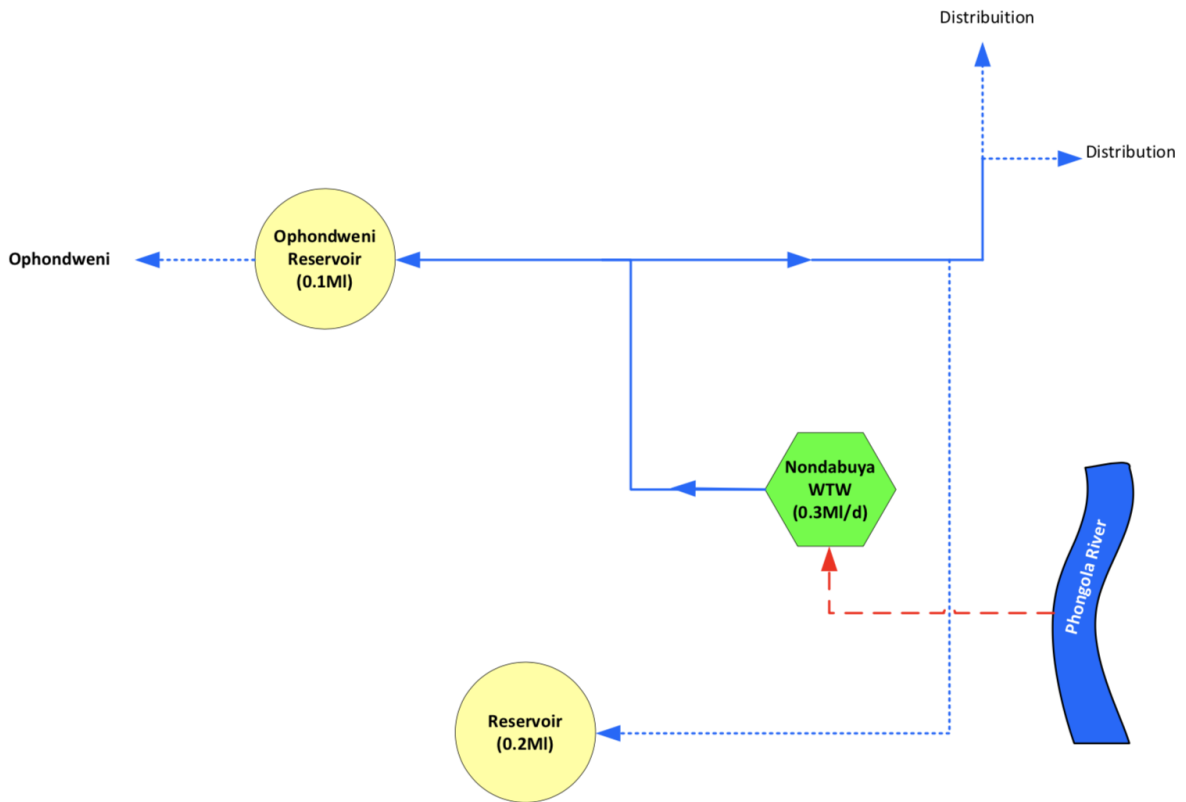

Figure 17.64 Schematic of Nondebuya WTP Supply System

**Table 17.77 Nondebuya Pipeline Details**

System	Pipeline Name	From	To	Length (km)	Nominal Diameter (mm)	Material	Capacity (Mℓ/day)	Age (years)
Phongola River	Raw Water	Phongola River	Nondabuya WTP	0.5	80*	*uPVC	0.3	42#
Phongola River	Potable Water	Nondabuya WTP	Ophondweni Res	0.1	80*	*uPVC	0.15	42#
Phongola River	Potable Water	Nondabuya WTP	Reservoir (0,2MI)	0.1	80*	*uPVC	0.15	42#

**Table 17.78 Nondebuya Reservoir Details**

System	Reservoir Site	Reservoir Name	Capacity (Mℓ)	Function	TWL (mASL)	FL (mASL)
Phongola River	Nondabuya WTP	Ophondweni Res	0,1 MI	Distribution	165*	160*
Phongola River	Nondabuya WTP	Reservoir (0,2MI)	0,3 MI	Distribution	252*	248*

## 18.2.9 Othobothini Water Treatment Supply System

The Othobothini Water Treatment Plant (**Figure 17.65, Table 17.79**) is located North East of Jozini within the uMkhanyakude District Municipality. The Othobothini WTP obtains raw water from the uPhongolo River which is then pumped to the Othobothini Water Treatment Plant.

The water is treated and distributed to a 200 kℓ Reservoir, which in turn supplies the area of Othobothini and its surrounding communities through both gravity and pumping system (**Table 17.80, Table 17.81, Table 17.82**). The maximum processing capacity of the plant is 2 Mℓ/day.

The current operating capacity of the plant is 0.5 Mℓ/day.

Othobothini Water Treatment Works New (20Mℓ/day upgradeable to 40Mℓ/day is under construction). The bulk backbone extends from Othobothini rural area towards Hlatikula and Mombeni along road D 1837, north of Othobothini rural towards Ophondweni and its diameter ranges from 250 to 320 mm diameter for Hlatikhulu/ Mombeni section and 220 to 350 mm diameter for the Ophondweni line.



**Figure 17.65** shows an aerial view of the Othobothini WTP (unknown source).

**Table 17.79 Characteristics of the Othobothini WTP.**

<b>WTP Name:</b>	Othobothini WTP Old
<b>System:</b>	uPhongolo Supply System
<b>Maximum Design Capacity:</b>	2 Mℓ/day
<b>Current Utilisation:</b>	0.5 Mℓ/day
<b>Raw Water Storage Capacity:</b>	200 kℓ
<b>Raw Water Supply Capacity:</b>	0.5 Mℓ/day
<b>Pre-Oxidation Type:</b>	None
<b>Primary Water Pre-Treatment Chemical:</b>	Polymeric Coagulant
<b>Total Coagulant Dosing Capacity:</b>	ℓ/hour -
<b>Rapid Mixing Method:</b>	Conventional Paddle Flash Mixer
<b>Clarifier Type:</b>	Circular
<b>Number of Clarifiers:</b>	2
<b>Total Area of all Clarifiers:</b>	m <sup>2</sup>
<b>Total Capacity of Clarifiers:</b>	Mℓ/day
<b>Filter Type:</b>	Pressure Sand Filters
<b>Number of Filters:</b>	2
<b>Filter Floor Type</b>	Filter Sand
<b>Total Filtration Area of all Filters</b>	m <sup>2</sup>
<b>Total Filtration Design Capacity of all Filters:</b>	Mℓ/day or m <sup>3</sup> /hr
<b>Total Capacity of Backwash Water Tanks:</b>	0m <sup>3</sup>
<b>Total Capacity of Sludge Treatment Plant:</b>	None
<b>Capacity of Used Washwater System:</b>	Mℓ/day
<b>Primary Post Disinfection Type:</b>	Sodium Hypochlorite
<b>Disinfection Dosing Capacity:</b>	4 ℓ/hr
<b>Disinfectant Storage Capacity:</b>	25 ℓ tanks
<b>Total Treated Water Storage Capacity:</b>	200kℓ

Figure 17.66 shows a schematic of the Othobothini Supply System



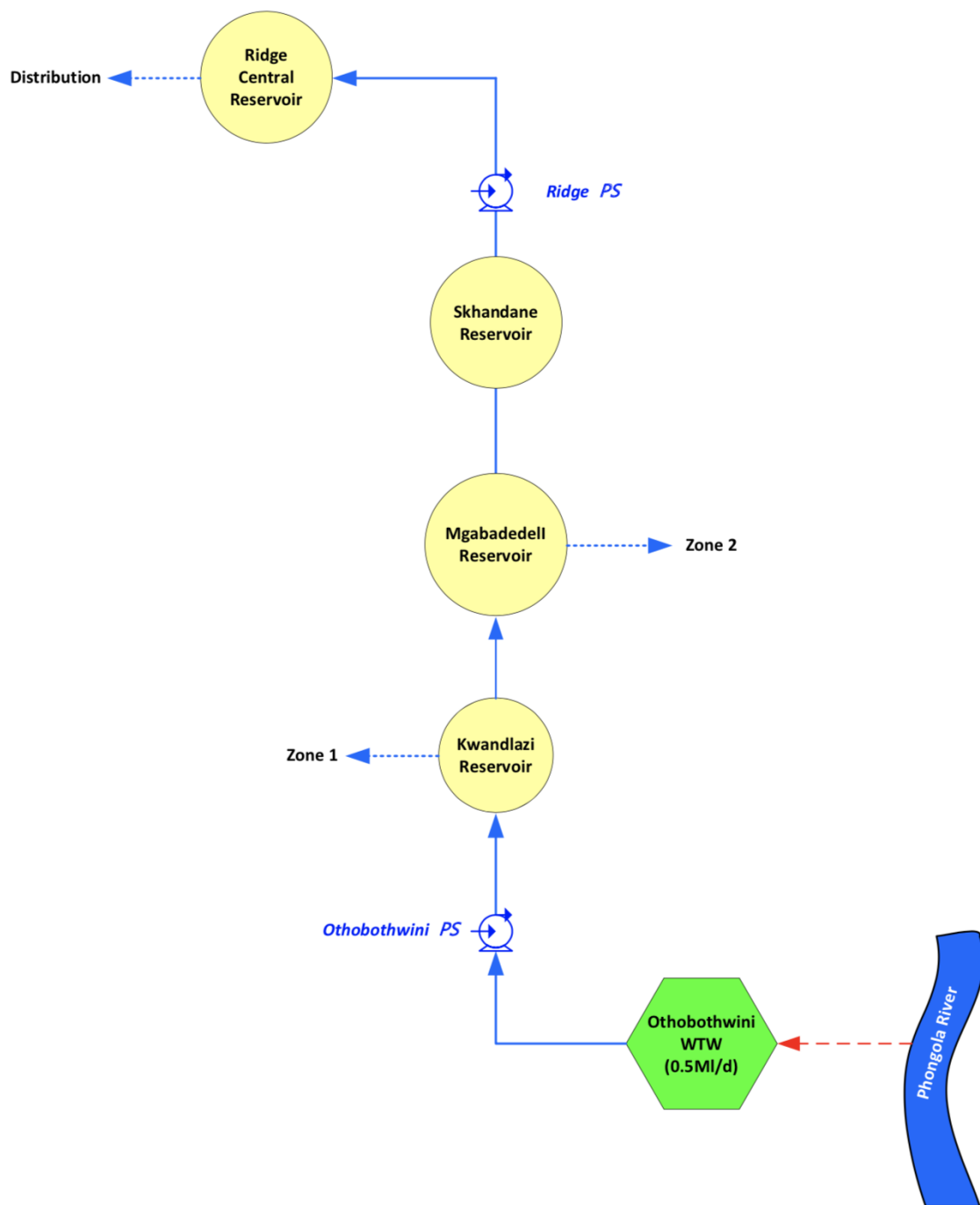

Figure 17.66 Schematic of Othobothini WTP Supply System

**Table 17.80 Othobothini Pump Details**

System	Pump Station Name	Number of Pumps		Pump Description	Supply From	Supply To	Static Head (m)	Duty Head (m)	Duty Capacity (Mℓ/day)
		Number of Duty Pumps	Number of Standby Pumps						
Phongolo	Raw Water PS	1	1		Phongolo River	Othobothini WTP	80		
Phongolo	Othobothini PS	2	1		Othobothini WTP	Kwandlazi Res			
Phongolo	Ridge PS	1	1		Skhandane Res	Ridge Central Res			

**Table 17.81 Othobothini Pipeline Details**

System	Pipeline Name	From	To	Length (km)	Nominal Diameter (mm)	Material	Capacity (Mℓ/day)	Age (years)
Phongolo	Othobothini bulk	Othobothini WTP	Othobothini PS		80	Steel	1.0*	41#
Phongolo	Othobothini bulk	Othobothini PS	Kwandlazi Res		50	Steel	0.7	41#
Phongolo	Othobothini bulk	Kwandlazi Res	Mgabadedell Res		50	Steel	0.5	41#
Phongolo	Othobothini bulk	Mgabadedell Res	Skhandane Res		50	Steel	0.3	41#
Phongolo	Othobothini bulk	Skhandane Res	Ridge Central Res		50	Steel	0.2	41#

**Table 17.82 Othobothini Reservoir Details**

System	Reservoir Site	Reservoir Name	Capacity (Mℓ)	Function	TWL (mASL)	FSL (mASL)
Othobothini	Othobothin WTP	Reservoir 1	200kl*	Storage		
Othobothini	Othobothin WTP	Elevated Tank	200kl*	Distribution		
Othobothini	Kwandlezi	Kwandlezi Res	200kl*	Terminal		
Othobothini	Mgabadedell	Mgabadedell Res	200kl*	Terminal		
Othobothini	Skhandane	Skhandane Res	200kl*	Balancing		
Othobothini	Ridge Central	Ridge Central Res	200kl*	Distribution	385*	380*

## 18.2.10 Jozini Water Treatment Supply System (Old & New)

The Jozini Old and New bulk pipelines extend from the Mseleni Town towards KwaMlamula in the north west and towards KwaSonto in the north east. The uPhongolo River and boreholes are the main water source for the Jozini bulk scheme. The information currently available indicates that the availability of water in the river and Phongolapoort Dam is insufficient to support the scheme. The bulk pipeline sizes range from 200mm to 250 diameters.

### (a) Jozini Old

The Jozini Water Treatment Plant (Old) (**Figure 17.67, Table 17.83**) is located in the town of Jozini just off the D1907 Road within the uMkhanyakude District Municipality close to the town of Hlabisa. The Old Jozini WTP supplies Hlabisa and surrounding areas. The majority of the households within the Jozini supply area also obtain water from local streams.

### (b) Jozini New

The Jozini Water Treatment Plant (New) (**Figure 17.68, Table 17.84**) is located in the town of Jozini just off the D1907 Road within the uMkhanyakude District Municipality. The Jozini New WTP receives raw water from the Jozini Dam via a channel and gravity Pump Station 2. The raw water is stored in a raw water holding tank before treatment. It is then pumped from the Jozini New Pumpstation (**Table 17.85**) to the Clear Water Makonyeni Storage Reservoir (**Figure 17.69, Table 17.87**). Thereafter it supplies the reticulation schemes of the Jozini Supply System (**Table 17.86**).

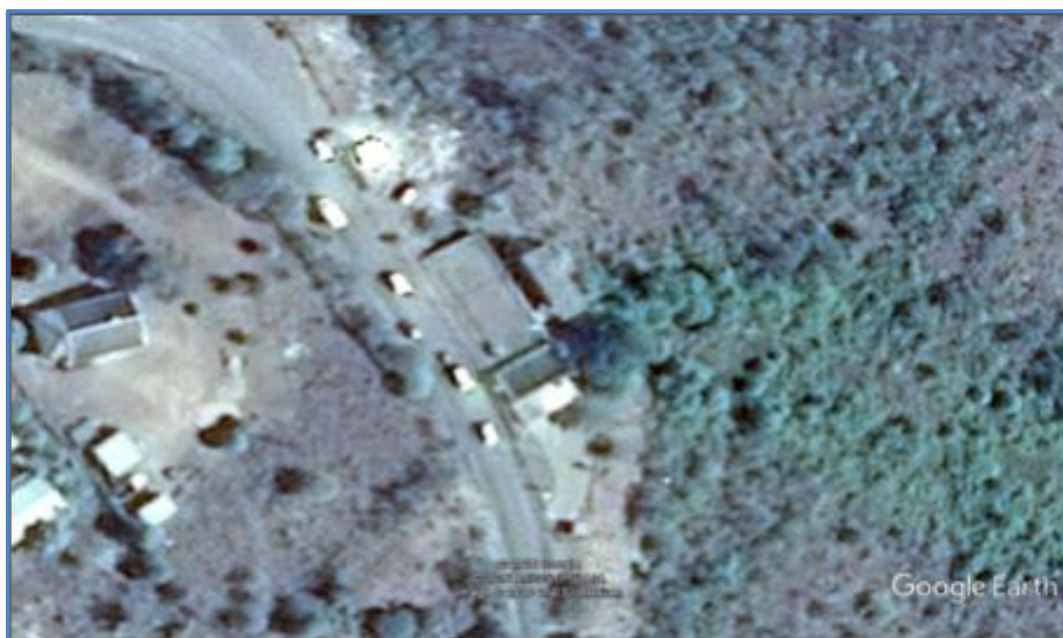

**Figure 17.67** Aerial view of Jozini Old Water Treatment Plant (Google Earth 2020: website).



Figure 17.68 Aerial view of Jozini New Water Treatment Plant (unknown source).



Figure 17.69 Aerial view of Jozini Reservoir (unknown source).



**Table 17.83 Characteristics of the Jozini OLD WTP.**

<b>WTP Name:</b>	Jozini OLD WTP (Bottom)
<b>System:</b>	uPhongolo River Supply System
<b>Maximum Design Capacity:</b>	2.5 Mℓ/day
<b>Current Utilisation:</b>	2.5 Mℓ/day
<b>Raw Water Storage Capacity:</b>	0 Mℓ
<b>Raw Water Supply Capacity:</b>	Mℓ/day
<b>Pre-Oxidation Type:</b>	None
<b>Primary Water Pre-Treatment Chemical:</b>	Polymeric Coagulant
<b>Rapid Mixing Method:</b>	Conventional Paddle Flash Mixer
<b>Clarifier Type:</b>	Dortmund Clarifier
<b>Number of Clarifiers:</b>	4
<b>Total Capacity of Clarifiers:</b>	2.5 Mℓ/day
<b>Filter Type:</b>	Pressure Filter Vessels (18) & Tanks (2)
<b>Number of Filters:</b>	20
<b>Filter Floor Type</b>	Filter Media
<b>Total Filtration Design Capacity of all Filters:</b>	1.6 Mℓ/day at 7m/h or 2.3 Mℓ/day at 9m/h
<b>Total Capacity of Backwash Water Tanks:</b>	None
<b>Total Capacity of Sludge Treatment Plant:</b>	None
<b>Capacity of Used Washwater System:</b>	0
<b>Primary Post Disinfection Type:</b>	Chlorine gas
<b>Disinfection Dosing Capacity:</b>	Unknown at this stage
<b>Disinfectant Storage Capacity:</b>	10 kg Chlorine Gas Cylinders
<b>Total Treated Water Storage Capacity:</b>	1 Mℓ/day*

**Table 17.84 Characteristics of the Jozini NEW WTP.**

<b>WTP Name:</b>	Jozini NEW WTP
<b>System:</b>	PongolaPoort Canal
<b>Maximum Design Capacity:</b>	5 Mℓ/day
<b>Current Utilisation:</b>	5 Mℓ/day
<b>Raw Water Storage Capacity:</b>	2 Mℓ/day
<b>Raw Water Supply Capacity:</b>	5 Mℓ/day
<b>Pre-Oxidation Type:</b>	None
<b>Primary Water Pre-Treatment Chemical:</b>	Polymeric Coagulant
<b>Total Coagulant Dosing Capacity:</b>	ℓ/hour
<b>Rapid Mixing Method:</b>	Conventional Paddle Flash Mixer
<b>Clarifier Type:</b>	Rectangular Clarifier
<b>Number of Clarifiers:</b>	2
<b>Total Capacity of Clarifiers:</b>	5 Mℓ/day
<b>Filter Type:</b>	Slow Sand Filters
<b>Number of Filters:</b>	4
<b>Filter Floor Type</b>	Filter Sand Media
<b>Total Filtration Design Capacity of all Filters:</b>	5 Mℓ/day
<b>Total Capacity of Backwash Water Tanks:</b>	None
<b>Total Capacity of Sludge Treatment Plant:</b>	Sludge Lagoons
<b>Capacity of Used Washwater System:</b>	None
<b>Primary Post Disinfection Type:</b>	Chlorine gas
<b>Disinfection Dosing Capacity:</b>	Unknown at this stage
<b>Disinfectant Storage Capacity:</b>	70Kg Cylinders
<b>Total Treated Water Storage Capacity:</b>	1 Mℓ/day*

Figure 17.70 shows a schematic of the Jozini Old Supply System

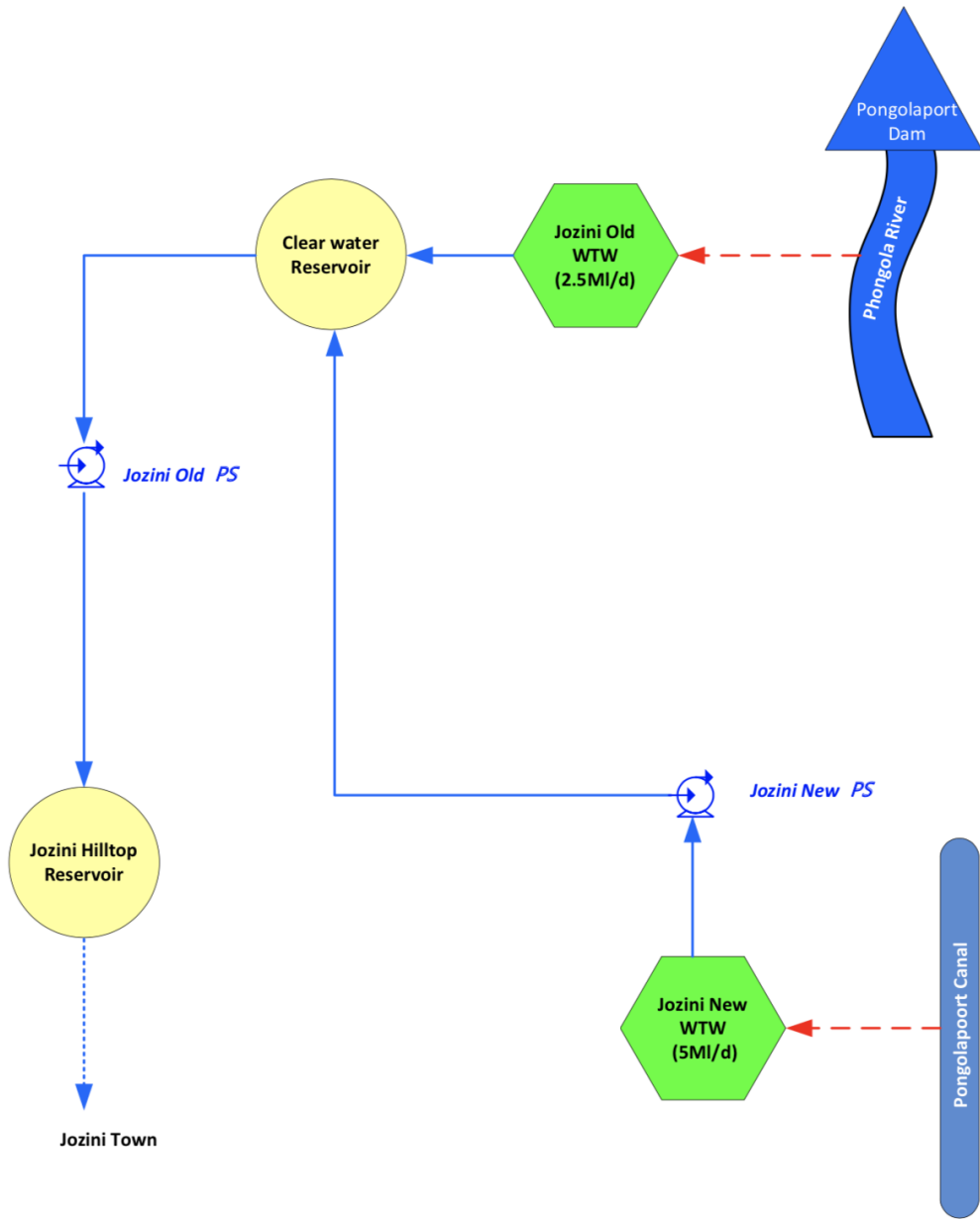

Figure 17.70 Schematic of Jozini WTP Supply System

Figure 17.71 shows a schematic of the Jozini New Supply System

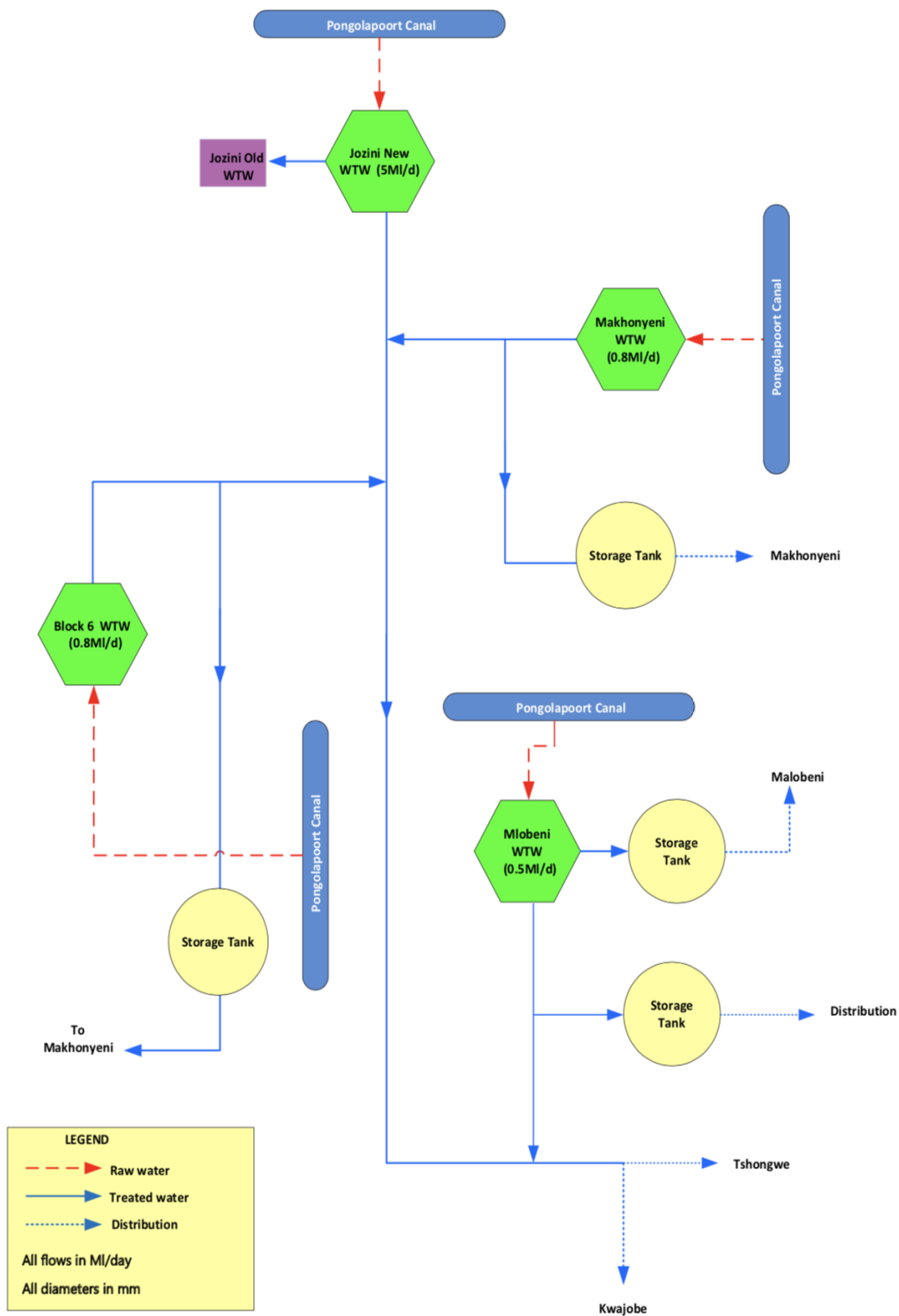

Figure 17.71 Schematic of Jozini WTP Supply System

**Table 17.85 Jozini Pump Details**

System	Pump Station Name	Number of Pumps		Pump Description	Supply From	Supply To	Static Head (m)	Duty Head (m)	Duty Capacity (Mℓ/day)
		Number of Duty Pumps	Number of Standby Pumps						
Phongola River	Jozini Old PS	2	1		Jozini Clear Water Res	Jozini Hilltop Res	180	265	2.5
PhongoaPoort Canal	Jozini New PS	2	1		Jozini New WTP	Jozini Old WTP	94	180	5.0

**Table 17.86 Jozini Pipeline Details**

System	Pipeline Name	From	To	Length (km)	Nominal Diameter (mm)	Material	Capacity (Mℓ/day)	Age (years)
Phongola River	Raw water pipeline	uPhongolo River (Canal)	Jozini Old WTP	0.5	100	Steel	2.5	42#
Phongola River	Potable water pipeline	Jozini Old WTP	Jozini Clear Water Res	1.0	100	Steel	5.0	7#

**Table 17.87 Jozini Reservoir Details**

System	Reservoir Site	Reservoir Name	Capacity (Mℓ)	Function	TWL (mASL)	FSL (mASL)
Phongola River	Jozini	Jozini Clear Water Res		Balancing	184*	180
Phongola River	Jozini	Jozini Hilltop Res		Distribution	269*	265
PhongoaPoort Canal	Makhonyeni	Makhonyeni Res		Storage	109*	105
PhongoaPoort Canal	Block 6	Block 6		Storage	136*	133
PhongoaPoort Canal	Mlobeni	Malobeni Tank 1		Distribution	94*	92
PhongoaPoort Canal	Mlobeni	Malobeni Tank 2		Distribution	94*	92



## 18.2.11 Shemula Water Treatment Supply System

The Shemula Bulk Water Supply System is currently served by one of two large capacity water treatment plants in the uMkhanyakhude District Municipality. The source for both the water treatment plants is the uPhongolo River. The remainder of the District is served by small conventional package treatment plants or schemes with chlorination only.

The Shemula Old WTP (**Figure 17.72**) has a design capacity of 7 Mℓ/day and. The newly commissioned Shemula New water treatment plant (**Figure 17.73** and **Table 17.88**) has a design capacity of 20 Mℓ/day. Treated water from Shemula Water Treatment Plant is pumped (**Table 17.89**) through a rising main (**Table 17.90**) to Shemula Command Reservoir (**Table 17.91**) where it is stored and supplied to Ndumo and Mboza Reservoirs. Ingwavuma Command Reservoir 01 and Ingwavuma Command Reservoir 02, supplied from the Shemula WTP, are located in the town of Ingwavuma. Ndumu Town Reservoir located in Ndumo receives its water from Shemula Booster pumpstation, where it is stored and supplied via gravity to the Shemula Elevated Tank.



**Figure 17.72** Aerial view of the Shemula (Old) WTP (unknown source).

Figure 17.73 shows an aerial view of the Shemula (New) WTP



Figure 17.73 Aerial view of Shemula New Water Treatment Plant (Google Earth 2020: website).

**Table 17.88 Characteristics of the Shemula NEW WTP.**

<b>WTP Name:</b>	Shemula Old and New WTP
<b>System:</b>	uPhongolo River
<b>Maximum Design Capacity:</b>	Old 7 Mℓ/day New 20 Mℓ/day (Augmentation)
<b>Current Utilisation:</b>	27 Mℓ/day
<b>Raw Water Storage Capacity:</b>	4.5 MI*
<b>Raw Water Supply Capacity:</b>	27 Mℓ/day
<b>Pre-Oxidation Type:</b>	None
<b>Primary Water Pre-Treatment Chemical:</b>	Coagulant
<b>Total Coagulant Dosing Capacity:</b>	ℓ/hour
<b>Rapid Mixing Method:</b>	Conventional Paddle Flash Mixer
<b>Clarifier Type:</b>	Clarifloculator
<b>Number of Clarifiers:</b>	2
<b>Total Capacity of Clarifiers:</b>	27 Mℓ/day
<b>Filter Type:</b>	Rapid Gravity Sand Filters
<b>Number of Filters:</b>	4
<b>Filter Floor Type</b>	Filter Sand Media
<b>Total Filtration Design Capacity of all Filters:</b>	20 Mℓ/day
<b>Total Capacity of Sludge Treatment Plant:</b>	Sludge Lagoons*
<b>Capacity of Used Washwater System:</b>	Mℓ/day
<b>Primary Post Disinfection Type:</b>	Chlorine gas
<b>Disinfection Dosing Capacity:</b>	Unknown at this stage
<b>Disinfectant Storage Capacity:</b>	1 Tonne Cylinders*
<b>Total Treated Water Storage Capacity:</b>	2.5 MI; 4.5MI existing reservoir

Figure 17.74 shows a schematic of the Shemula Supply System

**Shemula, Ndumo, Ngwavuma  
& Phelandaba Existing  
Schematic Diagram**

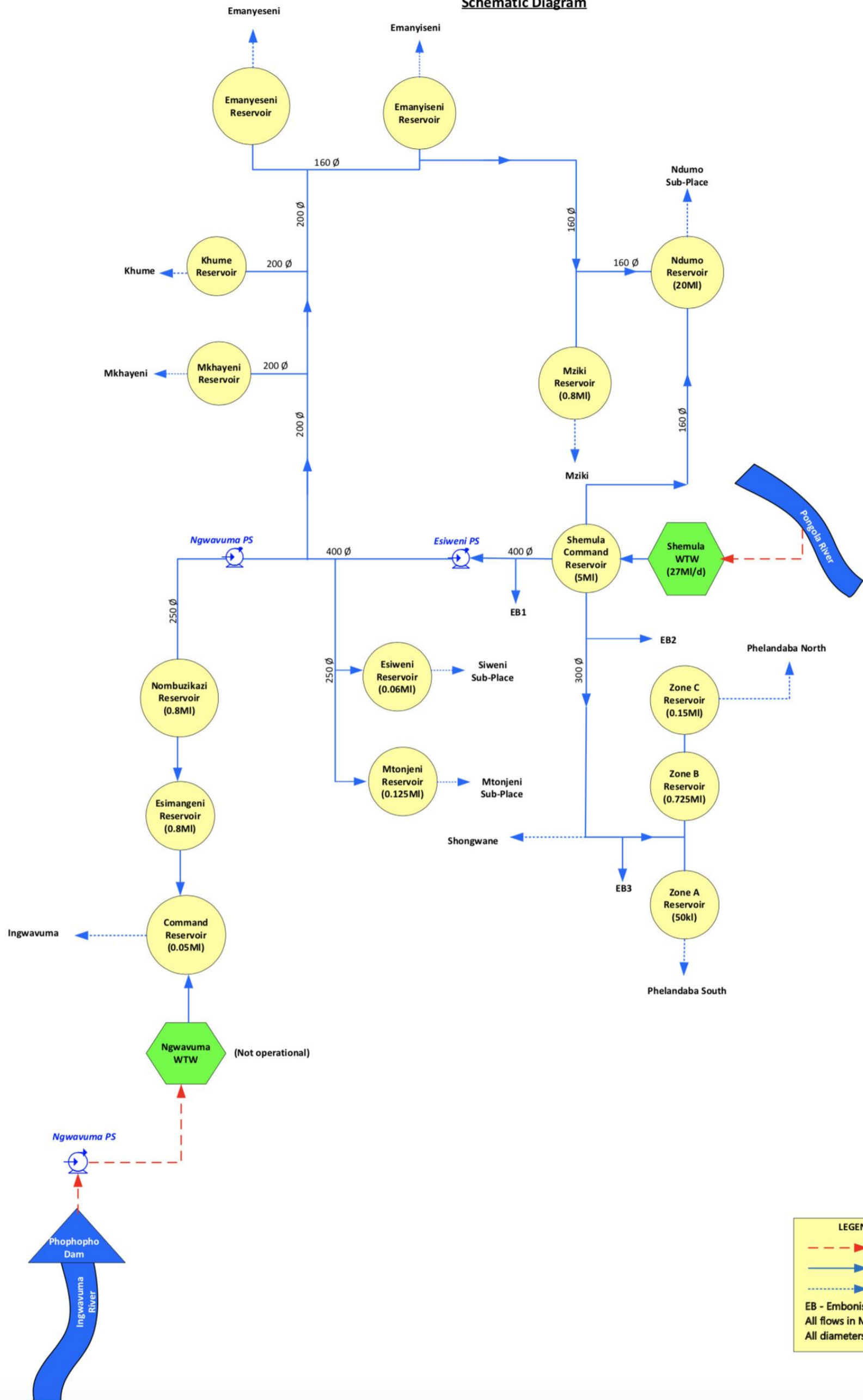

Figure 17.74 Schematic showing the Shemula Supply System

**Table 17.89 Shemula Pump Details**

System	Pump Station Name	Number of Pumps		Pump Description	Supply From	Supply To	Static Head (m)	Duty Head (m)	Duty Capacity (m <sup>3</sup> /hr)
		Number of Duty Pumps	Number of Standby Pumps						
uPhongolo River	Raw Water PS	2	1	ETA 200-40, 75kw motor	uPhongolo River	Shemula Command Res	33	49	520 m <sup>3</sup> /hr
uPhongolo River	Clear Water PS	3	1	Centrifugal multistage WKLN 150-4, 250kw motor	Shemula Command Res	Ngwavuma PS & supply reservoirs	53	70	80 m <sup>3</sup> /hr
uPhongolo River	Esiweni PS/Phuntaza PS	2	1		Shemula Command Res	Ngwavuma PS & supply reservoirs	114	134*	50 m <sup>3</sup> /hr*
uPhongolo River	Ngwavuma PS	2	1		Shemula Command Res	Nombuzikazi Res	124	140*	

**Table 17.90 Shemula Pipeline Details**

System	Pipeline Name	From	To	Length (km)	Nominal Diameter (mm)	Material	Capacity (Ml/day)	Age (years)
Phongola River	Raw water pipeline	Phongola River	Shemula WTP	1.5	700	Steel	20	7
Phongola River	Potable water pipeline	Shemula WTP	Shemula Command Res	2.5	700	Steel	20	7
Phongola River	Potable water pipeline	Shemula Command Res	Esiweni PS	5.0*	400	Steel	10*	7
Phongola River	Potable water pipeline	Esiweni PS	Ngwavuma PS	10.0*	300	Steel	2*	7
Phongola River	Potable water pipeline	Esiweni PS	Esiweni Reservoir	10.0*	250	Steel	2*	7
Phongola River	Potable water pipeline	Esiweni PS	Ndumo Reservoir	10.0*	400	Steel	20	7
Phongola River	Potable water pipeline	Ngwavuma PS	Nombuzikazi Reservoir	10.0*	250	Steel	0.8	7



**Table 17.91 Shemula Reservoir Details**

System	Reservoir Site	Reservoir Name	Capacity (Mℓ)	Function	TWL (mASL)	FL (mASL)
Phongola River	Shemula	Shemula Command Res	10	Balancing	50*	45
Phongola River	Ndumo	Ndumo Reservoir	2 x 5	Distribution	160*	155
Phongola River	Ndumo	Esiweni Reservoir	150kl	Distribution	253*	251
Phongola River	Ndumo	Mtonjeni Reservoir	0,125	Distribution	322*	320
Phongola River	Ngwavuma	Ngwavuma Command Reservoir	570kl	Distribution	85	83

## 18.3 Status Quo and Limitations

### 18.3.1 Hlobane/Coronation Supply System

The Hlobane WTP is in need of major refurbishment. Hlobane Reservoir 2, a steel tank, is also badly corroded and failure of this unit would have consequences on water supply to the town.

The Zululand District Municipality does not foresee the demand increasing beyond the current capacity of the plant and upgrading of the plant may not be necessary in the short to medium term.

Similarly, the Coronation WTP is now classed as aging infrastructure. The Coronation village is no longer an active mining village and the population is only a fraction of its previous figures. It is recommended that planned maintenance be implemented at the WTP to ensure that a reliable and efficient operation continues in the medium term and, at present, there is no need to extend / upgrade the WTP.

The Zululand District Municipality is in the process of identifying Regional Bulk Water Supply Schemes, to, ultimately, absorb these smaller schemes. As a result, the Hlobane and Coronation Supply Systems will be incorporated in the Greater Khamabi Regional Bulk Water Supply Scheme. A detailed feasibility study would be required to confirm the viability and financial implications of this regional scheme.

### 18.3.2 uMkhuze Supply System

The 1.5 Mℓ/day uMkhuze WTP has been upgraded. This upgrade, however, did not include an increase of the raw water supply infrastructure. The water is pumped from the Jozini Dam to Blackie Dam and then pumped to the uMkhuze River. The R34 million upgrades included the following:

- Construction of 1Mℓ Concrete Reservoir
- Construction of rapid gravity sand filter
- Construction backwash pump station
- Construction of Chlorine building & blower room
- Construction of chemical dosing unit
- Construction of Pipework, chambers and manholes
- Renovation of WTP including buildings and concrete structures

The Ubombo WTP requires to be upgraded and refurbished. A bulk line has been proposed from Jozini New WTP via Mkhuze to Mhlekezi which includes a new bulk line to supply Jozini Town and augment Mkhuze and uMhlekezi. Jozini New is a 5 Mℓ/day plant abstracting water from the irrigation canal fed from Pongolapoort Dam. uMhlekezi Water proposed a bulk pipeline to Mkhuze and Mhlekezi.

From the Demand model, a 250mm diameter pipe from the water treatment plant to uMkhuze has been recommended and a 200 mm diameter pipeline from Bethesdal Hospital to Mhlekezi. The total water demand for Jozini, Mkhuze and Bethesdal WTP is 5.8 Mℓ/day, while the capacity of the three plants adds up to 6.8 Mℓ/day; therefore, the treatment plants are sufficient to supply those three areas currently.

## 18.3.3 Simdlangentsha West RBWSS

### (a) Edumbe WTP Supply System

The 2018 potable water demand for the supply area was 2.7 Mℓ/day and the abstraction was 3 Mℓ/day. The current registered water use for the town of Paulpietersburg and Edumbe Township is 0.87 Mℓ/day and insufficient to meet the current raw water abstraction requirements for the Edumbe WTP although the Edumbe Dam has a firm yield to sustain the current demand. The total storage capacity of the Edumbe WTP Supply System is 5 Mℓ, which amounts to an average 46 hour storage capacity, but in summer months this reduces to a 30 hour storage capacity.

The WTP is coping with the required demand and is producing water of a reasonable quality.

### (b) Frischgewaagd WTP Supply System

Frischgewaagd WTP (**Figure 17.75**) is the largest of three plants that supply the Simdlangentsha West Regional Water Supply Scheme with a design capacity of 2 Mℓ/day. The Frischgewaagd WTP do encounter operational problems from time to time because of seasonal changes to the quality of the raw water, particularly the high turbidity levels that are experienced in summer.

Growing demand in the area has the WTP operating at 98% of its design capacity and with operational difficulty renders the plant insufficient to meet the demand.

Zululand District Municipality is in the process to consolidate the smaller WTP's with the larger ones and set up a regional BWSS. The Frischgewaagd WTP is one such plant and ZDM is busy with the construction of a 15 Mℓ/day WTP next to the Phongola River to serve the Simdlangentsha West Regional Water Supply Scheme.



**Figure 17.75 Construction of new 15 Mℓ /day WTP at Frischgewaagd along the Phongola River (Google Earth 2020: website).**

## 18.3.4 Simdlangentsha Central RBWSS

### (a) Belgrade WTP's Supply Systems

Although the area is generally well-served, all schemes are old, and regional scheme planning will include infills to provide water to additional households. The existing Sim Central Package Plant (4Mℓ/day) is running at full capacity and cannot supply the remaining regional supply area as it also supplies the northern section of Simdlangentsha East. Simdlangentsha East does not receive adequate water all the way from the Pongola abstraction works.

## 18.3.5 Simdlangentsha East RBWSS

### (a) Spekboom and Phongola WTP's Supply Systems

The Simdlangentsha East RBWSS supplies water to the town of Phongolo as well as a vast rural area which stretches from the border with Swaziland in the north, the communities of Manyandeni and Highlands to the east and the Pongola River to the south and Spekboom to the west

The design capacity of the uPhongolo Water Treatment Plant (WTP) is for an average annual daily flow rate of 8 Mℓ/day. The maximum flow rate of the treatment plant is 12 Mℓ/day. The current treated water production from the Phongola Regional WTP alone was 8.37 Mℓ/day (3.05 million m<sup>3</sup>/annum) in 2018, which represents 105% of its design capacity.

It is the intention of the Zululand District Municipality to develop the Simdlangentsha East Regional Water Supply Scheme to supply water for domestic use to the whole of the Simdlangentsha East area including the communities currently supplied from springs or not supplied at all. The current capacity of the Phongola WTP alone is insufficient to meet the future water requirements of the villages and rural towns in its intended supply area. The capacity of the Phongola WTP will need to be upgraded in the near future if it is to supply the whole of the Simdlangentsha East Regional Water Supply Scheme area.

### (b) Umkhanyakhude WTP Supply System

The areas within the UKDM area are supplied by various smaller WTP which are unable to meet the current demands. The Shemula Water Master Plan Supply Area covers the northern-most area of the UKDM cutting across the Jozini and uMhlabuyalinga Local Municipalities. The Jozini Water Master Plan Supply Area is in the northern half of the UKDM, cutting across the southern parts of Jozini and uMhlabuyalinga LMs.

The uMkhanyakhude District Municipality have a registered water allocation of 13.5 million m<sup>3</sup>/annum or 37 Mℓ/day at the Jozini New WTP abstraction weir. The Jozini Regional Bulk upgrade is in the implementation phase. The Shemula WTP has been augmented by 20 Mℓ/day. A new Othobothini 40 Mℓ/day treatment works is under construction (**Figure 17.76**) and will have the capacity to supply the future demand for the scheme area including the proposal to supply Hluhluwe Phase 3. The 40 Mℓ/day extension and upgrade will be adequate to meet the future demands beyond 2035. The planned bulk line from Othobothini to augment the water deficits currently experienced is under construction. The 22 km, 200 mm diameter bulk distribution lines from Othobothini will augment Nondabuyo. Both bulk lines from Othobothini and from Bhokweni to Matshamhlophe have calculated volumes to meet the 2045 projected water demand for Othobothini and the surrounding communities.

The Othobothini to kwaJobe Branch, 250mm diameter bulk pipeline, when compared with the demand model is not adequate. The bulk lines have already been installed. The recommendation is to construct another 250 mm diameter pipe parallel to the existing one. The All Town strategies report states that the Nondabuyo 150 kℓ reservoir, precast concrete with a steel roof, is insufficient to meet the current and future 48 hours storage required. The recommendation is that a 3.5 Mℓ storage reservoir is required to meet the demands for the area.

The Regional Water Treatment Plant, this component of the project consists of the construction and installation of the following infrastructure:

- Raw Water Abstraction Works: A new raw water abstraction works capable of abstracting 40Mℓ per day (20Mℓ per day in Phase 1) is constructed on the banks of the uPhongolo River.
- Raw Water Rising Main: A new raw water rising main to carry raw water from the abstraction works to the new treatment works (800mm diameter, 1760 m long steel pipe from the River Abstraction Works).
- Water Treatment Plant: The construction a new water treatment plant (WTP) capable of treating 20Mℓ of water per day. The site selected will make allowance for future expansion of the WTP when this is required.
- Storage Reservoir: A balancing / storage reservoirs capable of storing 4.2Mℓ of treated water will be built at the water treatment plant.
- Potable Water Rising Main: A new potable water rising main (800mm in diameter, 2800m long) from the new treatment works to carry potable water to the KwaNdlazi (Jozini Local) reservoir



**Figure 17.76 Aerial view of Regional Water Treatment Plant (NEW) (unknown source).**



## 18.4 Water Balance/Availability

### 18.4.1 uMkhuze Water Supply System

The first order water balance of the uMkhuze catchment suggests that there is a system deficit and part of the reason is the lack of storage in the system which would improve assurance of supply. According to ZD-WSDP, 2004 the deficit is also as a result of the provision made for future implementation of the Reserve.

A reconciliation undertaken, which includes both Coronation and Khambi Water Supply Schemes, with estimated water requirements of 1 million m<sup>3</sup>/annum and 0.2 million m<sup>3</sup>/annum respectively, indicates that there is a deficit in the uMkhuze River (**Table 17.92**). This is as a result of irrigation utilising the entire available yield without maintaining water for the Reserve (Zululand DM ZD-WSDP, 20004). The report suggests that this deficit can be addressed with the use of compulsory licensing and the re-allocation of water between different sectors.

**Table 17.92 Water Balance – Water availability in UMkhuze System for year 2000 (ZDM WSDP,2004)**

		UMkhuze (million m <sup>3</sup> /annum) 98% assurance
<b>Available Water</b>	Yield from Major Dams	0
	Yield from Minor Dams	5.6
	Run-of-River Yield	26.3
	Return flow	7.5
	Transfers in	30
	<b>Total available</b>	<b>64.4</b>
<b>Requirements</b>	Irrigation	74
	Urban & Rural	5
	Mining & Industry	0
	Ecological Requirements	13
	<b>Total Used</b>	<b>92</b>
<b>Balance</b>		<b>-27.6</b>

The water balance for the UMkhuze/Hluhluwe catchment, based on the net surface water resources as calculated in the DWAF 2004 Internal Strategic Perspective: Usuthu to Mhlathuze Water Management Area, and using updated and current registered use and return flows (WARMS December 2015) shows a deficit of 50.39 million m<sup>3</sup>/annum (**Table 17.93**).

A total volume of 14.8 Million m<sup>3</sup>/annum is registered for Hluhluwe Dam and the major water user downstream of the dam is irrigation agriculture. The main crops being irrigated are sugarcane and pineapples. Domestic water use is the other significant water user which includes the Hluhluwe Water Supply Scheme whose abstraction is directly from the Hluhluwe Dam. There is also 0.8 million m<sup>3</sup>/annum of forestry in the W32F catchment, which has some impact on the available water from the river. Based on the available information, the future water requirements for domestic water use

from the Hluhluwe Dam cannot be met at the required levels of assurance of supply and without curtailment of existing water uses.

**Table 17.93 uMkhuze Catchment Water Balance (Mhlathuze Water, 2016)**

uMkhuze Catchment	Available/Impact (million m <sup>3</sup> /annum)
Gross surface water resource	71
Ecological Reserve	-54
Invasive alien plants	-2
Net surface water resource	15
Groundwater	12
Agriculture return flow	6
Mining Return Flow W31	7.12
Urban Return Flow W31	0.26
Urban Return Flow W32	0.46
Transfer from uPhongolo	33
<b>Total Available</b>	<b>73.84</b>
Total Registered Water Use W31	-89.49
Total Registered Water Use W32	-34.74
<b>Water Balance</b>	<b>-50.39</b>

## 18.4.2 uPhongolo Water Supply System

UW, 2019 states that the yield of Pongolapoort Dam is estimated to be 530 million m<sup>3</sup>/annum. The environmental and Makhathini floodplain releases made from Pongolapoort Dam reduce the yield of the dam substantially by up to 250 million m<sup>3</sup>/annum (Zululand DM ZD-WSDP, 2004).

UW, 2019 suggests that the catchment yield is already oversubscribed by 133 million m<sup>3</sup>/annum. However, it is recognised that there is most likely overlap between the Ecological Reserve and Flood Release allocations for Makhathini flood plains, and so additional water could be available. Without this overlap there is surplus water available in the uPhongolo River system to meet the future water requirements of the domestic sector in the supply areas that can be supplied from or supported by the Pongolapoort Dam (**Table 17.94**).

**Table 17.94 Water balance - Water availability in uPhongolo System (ZD WSDP, 2004)**

		Bivane Dam	Pongolapoort Dam Incremental Catchment	Pongolapoort Dam Total Catchment
		(million m <sup>3</sup> /a) 98% assurance	(million m <sup>3</sup> /a) 98% assurance	(million m <sup>3</sup> /a) 98% assurance
Available Water	Yield from Major Dams	153	734	887
	Yield from Minor Dams	1.8	1.2	3.0
	Run-of-River Yield	0	0	0
	Return flow	1.8	17.4	19.2
	<b>Total available</b>	<b>156.6</b>	<b>752.6</b>	<b>909.2</b>
Requirements	Irrigation	18	169	197
	Urban & Rural	1	5	6
	Mining & Industry	0	1	1
	Ecological Requirements	62	152	152
	Transfers Out	0	35	35
	<b>Total Used</b>	<b>81</b>	<b>362</b>	<b>391</b>
<b>Balance</b>		<b>75.6</b>	<b>390.6</b>	<b>518.2</b>

As a short to medium term water reconciliation strategy option, the quantity of water that can be saved by implementing WC/WDM measures is significant in UMKhuze, Jozini town as well as Shemula water supply scheme (DWS, 2016). Therefore, WC/WDM measures should be implemented in the uPhongolo River system in order to reduce the amount of water required from the local water resources.

### 18.4.3 Lake Sibaya Water Supply Area

A study by Smithers et al. (2017) indicates that the demands for community water supply were in order of 1.35 million m<sup>3</sup>/annum (3.5 Mℓ/day) in the year 2014. This study used historical levels of afforestation and abstractions as input to the model, and for a specified minimum lake level of 16m above sea level. The maximum additional monthly abstraction that can be made is 0.085 million m<sup>3</sup>/month at a 98% assurance of supply (2.8 Mℓ/day). This yield shows a 90% increase on 2015 abstractions, and is maintaining simulated lake levels of more than 16.0m for 98% of the months simulated.

## 18.5 Recommendations

### 18.5.1 Simdlangentsha West Regional Bulk Water Supply Scheme (Frischgewaagd BWSS, Edumbe BWSS)

The following infrastructure upgrades and augmentation will be required in order to adequately supply the Simdlangentsha West RBWSS

- Upgrade the existing primary bulk pipeline from the Dumbe Dam to the Paulpietersburg WTP to  $\varnothing$  200mm;
- Upgrade existing secondary bulk pipelines (64km) ranging between  $\varnothing$  50mm and  $\varnothing$  500mm;
- Add secondary bulk pipelines ranging from  $\varnothing$  50mm and  $\varnothing$  200mm (38 km) and tertiary pipelines (27 km) ranging between  $\varnothing$  50mm and  $\varnothing$  200mm;
- Increase existing primary storage capacity (5.2M $\ell$ ) to 7.8 M $\ell$  and the existing secondary storage (1.6 M $\ell$ ) to 14.7 M $\ell$ . The existing tertiary storage capacity (5.6 M $\ell$ ) would need to increase to 9.7 M $\ell$ ;
- Additional secondary storage capacity of approximately 5.3 M $\ell$  would be required. The total tertiary storage that will be needed amounts to approximately 790 k $\ell$ .

### 18.5.2 Simdlangentsha Central Regional Bulk Water Supply Scheme (Belgrade BWSS)

The following infrastructure upgrades and augmentation will be required in order to adequately supply the Simdlangentsha Central RBWSS

Initiate hydrology studies to determine the yield of the rivers and spring from where the following infrastructure components could be commissioned:

- Construction of a new WTP (10M $\ell$ /day) at the existing weir at Mozana River;
- Upgrade 9km existing primary bulk pipeline ranging from  $\varnothing$  150mm to  $\varnothing$  450mm;
- Upgrade existing secondary pipelines (16km) ranging between  $\varnothing$  75mm and  $\varnothing$  450mm;
- Upgrade 18km existing tertiary pipelines (18km) ranging from  $\varnothing$  50mm to  $\varnothing$  160mm;
- Add secondary bulk pipelines ranging from  $\varnothing$  75mm to  $\varnothing$  250mm (29km) and tertiary pipelines (39km) ranging between  $\varnothing$  63mm and  $\varnothing$  140mm;

Increase existing storage capacities with 5.27M $\ell$ . Existing secondary storage (1.7M $\ell$ ) to be increased to 4.45M $\ell$  and existing tertiary storage (220k $\ell$ ) to 2.76M $\ell$ ;

- Additional secondary storage capacity of approximately 2.28 M $\ell$  would be required. The total tertiary storage that will be needed amounts to approximately 7.1M $\ell$ ; and
- Hydrology studies are required to determine the yield of the rivers.

### 18.5.3 Simdlangentsha East Regional Bulk Water Supply Scheme (Spekboom and Phongola WTP's Supply Systems)

The following infrastructure upgrades and augmentation will be required in order to adequately supply the Simdlangentsha East RBWSS

Initiate hydrology studies to determine the yield of the rivers from where the following infrastructure components could be commissioned:

- Upgrade the existing primary bulk pipelines (3.4km) to  $\varnothing$  200mm and  $\varnothing$  630mm;
- Upgrade 33.6km existing secondary pipelines ranging between  $\varnothing$  75mm and 630mm;
- Upgrade 91km existing tertiary pipeline ranging between  $\varnothing$  50mm and  $\varnothing$  250mm;
- Add secondary bulk pipelines ranging from  $\varnothing$  75mm to  $\varnothing$  250mm (7.5km) and tertiary pipelines (39km) ranging between  $\varnothing$  63mm and  $\varnothing$  140mm;
- Increase the existing secondary storage capacity (1.25M  $\ell$ ) to 10.85M  $\ell$  and the existing tertiary storage (3.8M $\ell$ ) to 14.47M $\ell$ ;
- Additional secondary storage capacity of approximately 2.28M  $\ell$  would be required. The total tertiary storage that will be needed amounts to approximately 7.1M $\ell$ ; and
- Hydrology studies are required to determine the yield of the rivers.

### 18.5.4 Lake Sibaya and Mkhuze System

It is recommended that detailed water resources analysis and reconciliation studies are undertaken for the entire uPhongolo System to determine a current water balance. It is recommended that detailed water resources analysis study is undertaken for the Lake Sibaya System to determine the current lake water balance.

The areas within the UKDM area are supplied by various smaller WTPs which are unable to meet the current demands and it is recommended that larger regional schemes are implemented in the long term. The Shemula Water Master Plan Supply Area covers the northern-most area of the UKDM cutting across the Jozini and uMhlabuyalinga Local Municipalities. The Jozini Water Master Plan Supply Area is in the northern half of the UKDM, cutting across the southern parts of Jozini and uMhlabuyalinga LMs.

The UKDM mainly receives their funding from the Municipal Infrastructure Grant (MIG) and the Water Services Infrastructure Grant (WSIG). One regional bulk infrastructure project received funding from the Regional Bulk Infrastructure Grant and that is the Pongolapoort Bulk Water Scheme in Jozini.

The results of the assessment conducted for this scheme has indicated that the proposed Shemula Bulk Water Supply Project will have sufficient capacity to supply the ultimate future demand. As this project has been sub-divided into 6 Phases, it is recommended that the various phases be in-line with the growing demands for the supply areas within the scheme i.e. the scheme to be completed by 2030.

The Umkhanyakude District Water Services Master Plan of 2016 proposed the following infrastructure capacity and upgrade requirements for Western and Central Shemula (Ingwavuma to Phelandaba) and is summarized as follows:



- *The current water treatment works of 7.5 Mℓ/day has been upgraded to 27.5Mℓ/day and will therefore address the current demand. There is a shortfall of 5Mℓ/day for the projected 2035 demand.*
- *The water treatment works will also supply the demand from Shemula Eastern Region. This will increase the demand of 32.6Mℓ/day to 36.7Mℓ/day if the Eastern Region current supply sources are retained or 44Mℓ/day if the ground water sources are discontinued.*
- *The Greater Mseleni Bulk Water Supply Scheme: The proposed Greater Mseleni Water Supply Scheme would convert the existing standalone schemes into a single regional scheme. Depending on the funding of the recommended hydrological studies on Lake Sibayi it may be feasible to upgrade the lake abstraction to 4.78Mℓ/day. This would allow the scheme to operate at its full design capacity and will remove the need to construct the bulk line from Jozini Dam to Mseleni. The proposed scheme will upgrade the abstraction and treatment works (which are currently only operating at 69 % capacity as a result of abstraction problems).*

It is recommended that the Jozini Regional Bulk Water Supply Project be further assessed to ensure that there is adequate capacity to meet the future demands for each supply area.

It is also recommended that detailed water resources analysis and reconciliation studies are undertaken for the entire uKDM Systems to determine a current water balance.

## REFERENCES

Department of Water Affairs. 2010. Water Supply and Drought Operating Rules for Stand-Alone Dams and Schemes Typical of Rural/Small Municipal Water Supply Schemes: Eastern Cluster. Prepared by BKS (Pty) Ltd. Department of Water Affairs: Pretoria.

Department of Water Affairs. 2013. Continuation of Reconciliation Strategies for All Towns (CRSAT) In The Eastern Region: Update of The Water Reconciliation Strategy of the White Mfolozi River System in Zululand District Municipality for The Period -2012 To 2040. Prepared by Tlou Consulting (Pty) Ltd in association with WR Nyabeze & Associates. Department of Water Affairs: Pretoria.

Mhlathuze Water. 2016. Umkhanyakude District Water Services Master Plan. Prepared by BIGEN AFRICA Services (Pty) Ltd. Mhlathuze Water: Richards Bay.

Umgeni Water. 2019. Universal Access Plan Phase Iii – Progressive Development of a Regional Concept Secondary Bulk Water Master Plan for The Zululand District Municipality. Prepared by Mariswe (Pty) Ltd. Umgeni Water: Pietermaritzburg.

Umgeni Water. 2020. Universal Access Plan Phase Iii – Progressive Development of a Regional Concept Secondary Bulk Water Master Plan for The Zululand District Municipality. Prepared by Mariswe (Pty) Ltd. Umgeni Water: Pietermaritzburg.

Zululand District Municipality Water Services Development Plan, 2004

Zululand District Municipality IDP, 2016

Department of Water and Sanitation. 2015. An update on the water reconciliation strategy options for the Nongoma supply system Zululand District municipality

DWS, 2014. Update of the water reconciliation strategy of the White Mfolozi River System in Zululand District Municipality

DWS, 2013. White Mfolozi river catchment; Vryheid, Ulundi, Emondlo and Nondweni water supply scheme areas including *Klipfontein, Bloemveld, Grootgewacht & Mvunyana dams as well as the Ulundi balancing weir.*

DWA, 2013. The Greater Nongoma water supply scheme: Vokwana Dam and Vuna Dam decision support system

DWS, 2018. *Pongolapoort Dam Short-term Yield Curves Development*

UW, 2019. UAP Phase III Umkhanyakude DM: Due Diligence Report

DWS, 2016. *Summary of water reconciliation strategy options for the schemes in the Umkhanyakude District Municipality*

Zululand District Municipality, 2004. *Zululand District Municipality Water Services Development Plan*

Lankford, Pringle, Dickens, *et al.* 2011 *Hydrological modelling of water allocation, ecosystem services and poverty alleviation in the Pongola floodplain, South Africa*

JC Smithers, RP Gray, S Johnson and D Still (2017). Modelling and water yield assessment of Lake Sibaya

<https://infrastructurenews.co.za>

R Meyer and L Godfrey, 2003. Report on the geohydrology around Lake Sibaya, Northern Zululand Coastal plain, KwaZulu-Natal

Umgeni Water. 2019. Universal Access Plan Phase III – Progressive Development of a Regional concept Secondary Bulk Water Master Plan for the UMkhanyakude District Municipality. Prepared by Mariswe and JTN Consulting. Umgeni Water: Pietermaritzburg.

Umgeni Water. 2020. Universal Access Plan Phase III – Progressive Development of a Regional concept Secondary Bulk Water Master Plan for the UMkhanyakude District Municipality. Prepared by Mariswe. Umgeni Water: Pietermaritzburg.

Mhlathuze Water. 2016. UMkhanyakude District Water Services Master Plan. Prepared by BIGEN AFRICA Services (Pty) Ltd. Mhlathuze Water: Richards Bay.

Zululand District Municipality Water Services Development Plan, 2004.

DWS. 2016. Development of Operating Rules for Water Supply and Drought Management for Stand-Alone Dams and Schemes: Eastern Cluster - Drought operating rules for Hluhluwe Dam

# ACKNOWLEDGEMENTS

Umgeni Water's comprehensive 2022 Infrastructure Master Plan has been updated and improved to produce this 2023 version. The concerted effort of the Planning Services Department as a whole in producing this document is acknowledged and appreciated. This was all achieved under ever trying conditions with many staff working remotely whilst contending with the COVID-19 Lockdowns. Specific contributions by the various team members deserves acknowledgement:

- Alka Ramnath (Planner) Project management, Section 2, Spatial information, Research and input to all volumes
- Graham Metcalf (Geohydrologist) Groundwater and Wastewater
- Gavin Subramanian (Planning Engineer) Infrastructure on the North Coast System
- Angus Nicoll (Planning Engineer) Infrastructure on the South Coast and Mgeni Central Systems
- Vernon Perumal (Planning Engineer) Infrastructure on the uMkhomazi, Upper uMzintlava, Upper uMzimkhulu and the uMhlathuze and Middle uThukela Systems and compiling the Energy Section
- Mark Scott (Planning Engineer) Infrastructure on the Mgeni Inland, uMfolozi, uMkhuze, uPhongolo and Lake Sibiya Systems
- Nathaniel Padayachee (Planning Engineer) Infrastructure on the Upper uThukela and Buffalo Systems
- Ntuthuko Ngcamu (Head – Water Demand Management Unit) with support from Siphokazi Mabaso, Mathews Nokhanga and Dillon Jacks Water Demand Management Section
- Sakhile Hlalukane (Hydrologist) Water resources of the North Coast, South Coast and Upper uThukela Systems
- Sandile Sithole (Hydrologist) Water resources of all systems excluding the North Coast, South Coast and Upper uThukela Systems
- Mlungisi Shabalala (Hydrologist) Water resources of the Middle uThukela, uMhlathuze, uMfolozi, uMkhuze, uPhongolo and Lake Sibiya Systems
- Sithembile Mbonambi (Hydrologist – Graduate Trainee) Water resources of the uMkhomazi, Upper uMzintlava and Upper uMzimkhulu Systems

The 2023 Infrastructure Master Plan was not completed by the abovementioned people without the valued assistance of numerous other persons and parties. Their contributions are gratefully acknowledged. These include Umgeni Water and WSA Operations Staff, Umgeni Water's Water and Environment Department (water quality) and Umgeni Water's Process Services Department (process and treatment details for UW plants and others).

Kevin Meier,  
MANAGER: PLANNING SERVICES